

# Design & Implementation of High Data Rate LTE System for Improving Capacity

Vanya Mehta<sup>1</sup>, Er. Timsi<sup>2</sup>

Research Scholar, ECE Dept., JCD College of Engineering and Technology, Sirsa, Haryana<sup>1</sup>

Assistant Professor, ECE Dept., JCD College of Engineering and Technology, Sirsa, Haryana<sup>2</sup>

**Abstract:** Long term evolution (LTE) is a 3GPP 4G technology which enhances the development in the field of telecommunication and by improving the performance of the network for the different types of traffic flows. 4G LTE is a packet based networks brings some improvements in the form of higher bit rate and lower latencies. OFDMA technique is used in downlink and SC-FDMA technique is used in uplink. PAPR of OFDMA is higher than SC-FDMA. This paper presents reduction in the values of PAPR for OFDMA in downlink system by using pulse shaping filter and capacity of LTE system is improved by using water filling algorithm.

**Keywords:** 4G LTE, Downlink, Uplink, OFDMA, SC-FDMA, QPSK, 16-QAM, 64-QAM, PAPR, LTE Capacity, SER.

## I. INTRODUCTION

Mobile telephony and mobile communication systems have been part of the modern telecommunication spectrum. As they became increasingly popular, a number of new systems were introduced, improving and evolving the existing approaches.

1G had fulfilled basic mobile voice while 2G represented Global system for Mobile, i.e.GSM has introduced capacity and coverage.

This is followed by 3G and 3.5G, which introduced packet switched data transmission & it allows support for data, voice and video information at higher speeds.

This new feature caused exponential growth and worldwide spread of 3G mobile communication standards. Evolution of wireless access technologies is about to reach its fourth generation (4G) Long Term Evolution (LTE).

### LTE FEATURES:

- Downlink peak rate: 300Mb/s
- Uplink peak rate: 75Mb/s
- Improved support for mobility.
- Low data transfer latencies( less than 5ms).
- OFDMA for downlink & SC-FDMA for uplink to conserve power.
- Increased spectrum flexibility: 1.4 MHz, 3 MHz, 5 MHz, 10 MHz, 15 MHz and 20 MHz
- Support atleast 200 active data clients in every 5 MHz cell.
- Packet switched radio interface.

### LTE ARCHITECTURE

Basic architecture contains following network elements:

#### a. LTE-EUTRAN:

It provides higher data rates, lower latency and is optimized for packet data. EUTRAN (Evolved Universal Terrestrial Radio) consists of eNB (Base station). EUTRAN is responsible for complete radio management in LTE.

#### b. LTE-EPC:

The LTE EPC consists of Mobility Management Entity (MME), Serving Gateway (SGW), PDN Gateway(PGW) and Home Subscriber server(HSS).

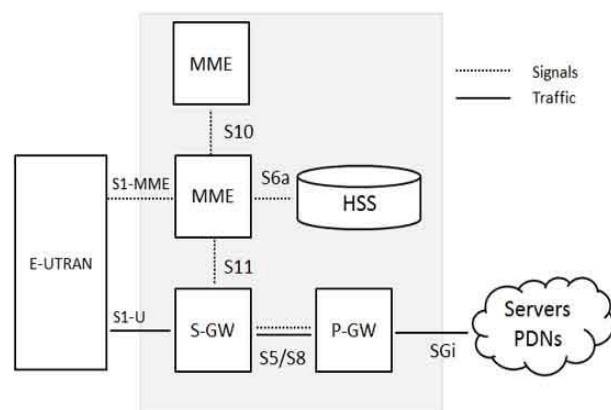

Fig. 1 LTE Architecture

The paper is ordered as follows. In section II, it defines system model which represents various steps included in proposed work and the performance parameters used. Section III represents the results. Finally, conclusion is explained in Section IV.

## II. PROPOSED WORK

### SYSTEM MODEL

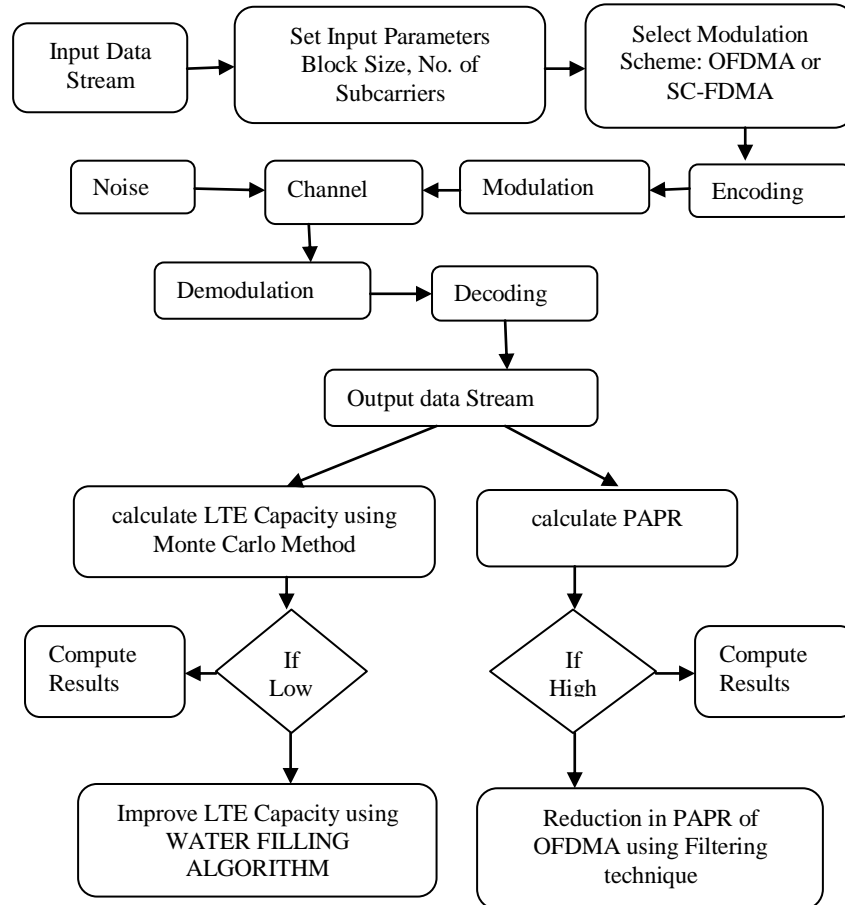

Fig. 2: System Model

### PROPOSED ALGORITHM

1. GENERATE INPUT DATA STREAM
2. SET INPUT PARAMETERS BLOCK SIZE, NO. OF SUBCARRIERS
3. CHOOSE MODULATION SCHEME
4. APPLY ENCODING AND MODULATION TO THE DATA
5. ADD AWGN NOISE IN CHANNEL
6. APPLY DEMODULATION AND DECODING PROCESS
7. CALCULATE PAPR VALUE
8. IF PAPR >LIMIT THEN  
APPLY FILTERING TECHNIQUE FOR REDUCING PAPR
- ELSE  
COMPUTE RESULTS
9. CALCULATE CAPACITY USING ITERATIVE METHOD

PRB=8:2:20;  
L1=length(PRB); Ntx =2;  
Nrx=2;

```

SNRdB=-10:1:20;
SNRlinear=10.^(SNRdB/10);
H = (randn(Nrx,Ntx)+1j*randn(Nrx,Ntx));
for i=1:L1
    C(i) =
    C(i)+log2(real(det(I+SNRlinear(i)*Ntx*H)));
end
10. IF CAPACITY <LIMIT THEN
IMPROVE THE CAPACITY USING WATER FILLING
CONCEPT
for i=1:L
    Capacity(i) = Capacity(i)+(1/N * sum(log2(1+
PowerAllo.' .* H)));
end
ELSE
COMPUTE RESULTS
11. END
    
```

### PERFORMANCE PARAMETERS

#### 1. Mathematical Calculation for PAPR

The complex data block for the OFDM signal to be transmitted is given by

$$x(t) = \frac{1}{\sqrt{N}} \sum_{n=0}^{N-1} x_n e^{j2\pi n\Delta ft}, 0 \leq t \leq NT$$

The PAPR of the transmitted signal is defined as

$$PAPR = \frac{\max_{x_0 \leq t \leq NT} |x(t)|^2}{\frac{1}{NT} \int_0^{NT} |x(t)|^2 dt}$$

Normally, the complementary cumulative distribution function (CCDF) is used which helps to measure the probability that the PAPR of a certain data block exceeds the given threshold.

The CDF of the PAPR of the amplitude of a signal sample is given by:

$$F(z) = 1 - \exp(-z)$$

CCDF is given by:

$$\begin{aligned} P(\text{PAPR} > z) &= 1 - P(\text{PAPR} \leq z) \\ &= 1 - F(z)N \\ &= 1 - (1 - \exp(-z))N \end{aligned}$$

- PAPR is determined by combination of
  - Modulation
  - Constellation of the signal
  - Pulse shaping
- High PAPR reduces power amplifier efficiency since it must operate with large back off (higher PAPR requires higher back off and/or more linearity)

### 2. Significance of pulse shaping filter in PAPR analysis

In digital communication, pulse shaping is one of the methods of changing the waveform of the transmitted pulse. It helps in limiting the effective bandwidth of the transmission and also the ISI caused by the channel can also be kept in control. PAPR of an RRC will increase with reduced excess bandwidth and increased filter length.

### 3. LTE Capacity

Peak Capacity of LTE is the maximum possible capacity which can only be achieved in lab conditions. LTE Capacity depends on the following:

- Channel Bandwidth
- network Loading: number of subscribers in a cell which impacts the overhead.
- The Configuration & capability of the System: whether it is 2\*2 MIMO, SISO and MCS Scheme.

### 4. Carrier Aggregation

Carrier aggregation is used in LTE-Advanced in order to increase the bandwidth, and thereby increase the bit rate. Carrier Aggregation (CA) allows scalable bandwidth extension via aggregating multiple smaller band segments, each called a Component Carrier (CC), into a wider virtual frequency band to transmit at higher rates. The component carrier can have a bandwidth of 1.4, 3, 5, 10, 15 or 20 MHz.

### 5. Water Filling Algorithm

Water-filling algorithms are always performed iteratively to solve the power allocation problem. In this, linear iterative algorithm is proposed to increase the LTE capacity.

## IV. RESULTS

### 1. COMPARISON OF PAPR VALUE OF OFDMA & SC-FDMA

In order to gain high data bandwidth when transmitting packets, LTE integrates OFDM technology which can provide high-degree resilience to reflections and interference at the same time. SC-FDMA has the advantages of smaller PAPR. The OFDMA solution leads to high PAPR requiring Expensive Power amplifiers with high requirements on linearity, increasing power consumption for the sender.

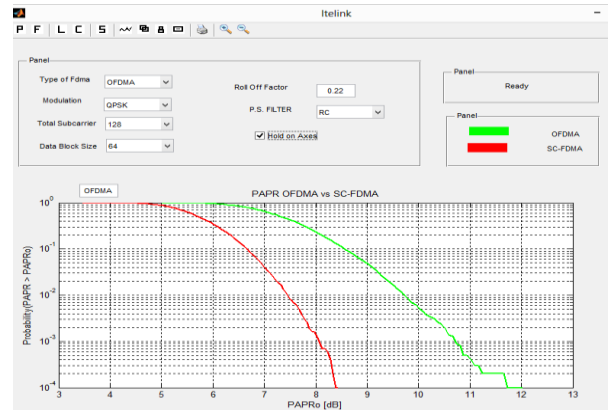

(a)

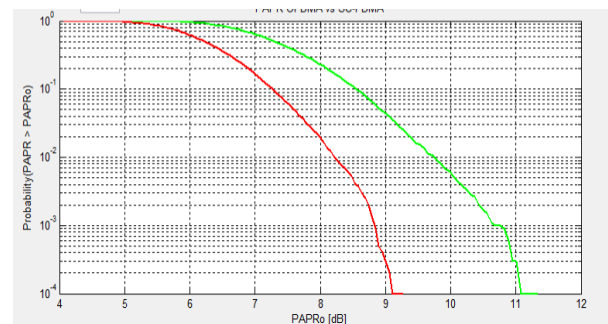

(b)

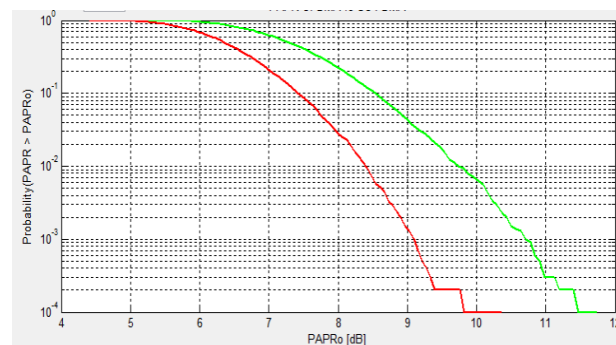

(c)

Fig 3. Comparison of PAPR values for various multiple access schemes for No. of subcarriers =128 and block size=64 using (a) QPSK modulation (b) 16 QAM (c) 64 QAM.

Table 1. Comparison of PAPR values for various multiple access schemes for No. of subcarriers =128 and block size=64 using (a) QPSK modulation (b) 16 QAM (c) 64 QAM.

MODULATION SCHEME	OFDMA	SC-FDMA
QPSK	8.4	12
16-QAM	9.2	11.2
64-QAM	10.3	11.8

2. COMPARISON OF PAPR VALUES OF OFDMA WITH AND WITHOUT USING FILTERING TECHNIQUE

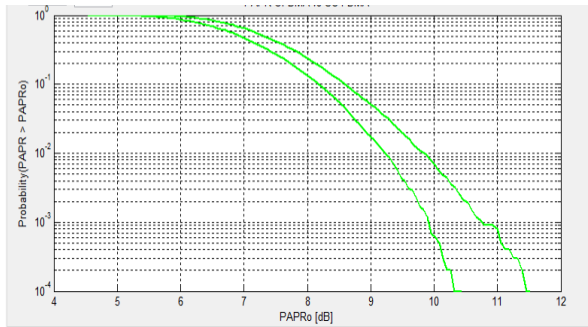

(a)

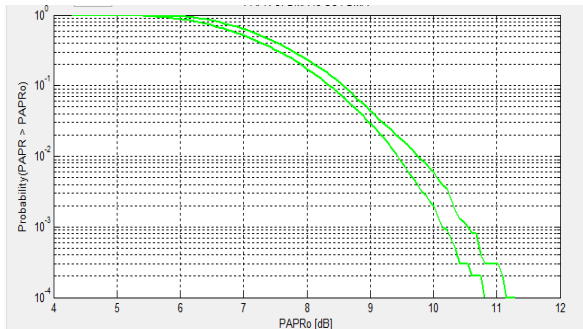

(b)

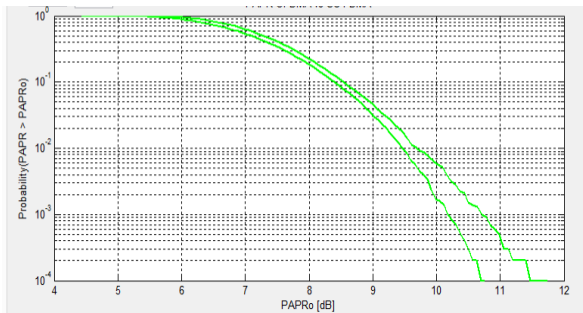

(c)

Fig 4.4 Comparison of PAPR values for OFDMA for No. of subcarriers =128 and block size=64 using (a) QPSK modulation (b) 16 QAM (c) 64 QAM

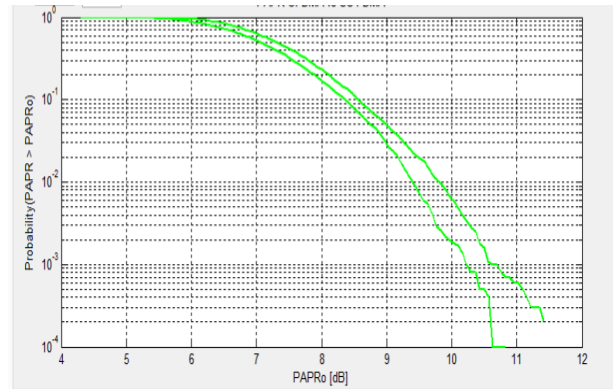

(a)

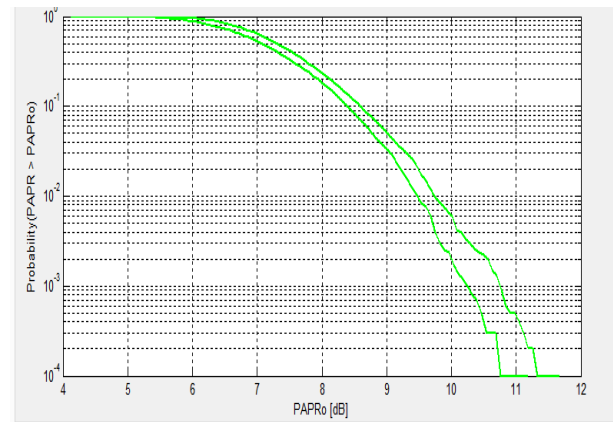

(b)

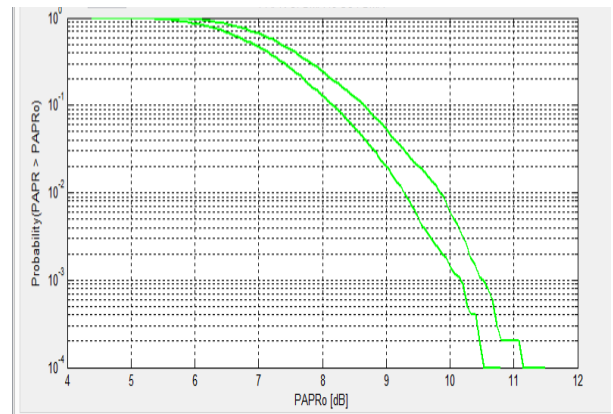

(c)

Fig 4.5. Comparison of PAPR values for OFDMA for No. of subcarriers =256 and block size=64 using (a) QPSK modulation (b) 16 QAM (c) 64 QAM.

Similarly results are calculated for comparison of PAPR values for OFDMA for No. of subcarriers =512,256,512 and block size=64,128,128 respectively using (a) QPSK modulation (b) 16 QAM (c) 64 QAM.

Table 4.2. Comparison of PAPR values of OFDMA with filtering technique and without filtering technique for different No. of subcarriers and different block size using QPSK modulation, 16-QAM and 64-QAM.

Number of Sub carriers	Block Size	MODULATION SCHEME	PAPR with Filter	PAPR without Filter
128	64	QPSK	10.4	11.5
		16-QAM	10.9	11.2
		64-QAM	10.8	11.7
256	64	QPSK	10.9	11.5
		16-QAM	10.9	11.2
		64-QAM	11.2	11.8
512	64	QPSK	10.8	11.5
		16-QAM	10.9	12.1
		64-QAM	10.8	12.1
256	128	QPSK	9.9	11.9
		16-QAM	10.1	11.5
		64-QAM	10.6	11.6
512	128	QPSK	9.9	11.9
		16-QAM	10.2	12.3
		64-QAM	10.9	11.5

### 3. COMPARISON OF LTE CAPACITY OF OFDMA WITH AND WITHOUT USING WATER FILLING ALGORITHM

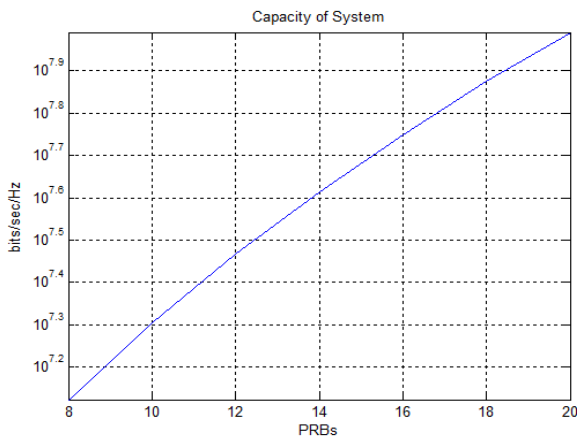

(a)

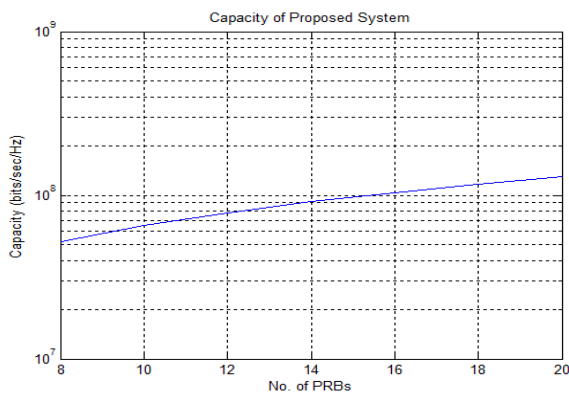

(b)

Fig 4.6 Comparison of LTE Capacity for QPSK Modulation using (a) Monte Carlo Method (b) Water Filling Algorithm

Similarly results are calculated for comparison of LTE Capacity for 16 QAM and 64 QAM.

Table 4.3. Comparison of values of LTE CAPACITY using Monte Carlo Method and Water Filling Algorithm using QPSK modulation, 16-QAM and 64-QAM.

Modulation Scheme	LTE Capacity with MONTE CARLO METHOD	LTE Capacity with WATER FILLING ALGORITHM
QPSK	100	158.5
16-QAM	199	257.1
64-QAM	309	398.1

### 4. Symbol Error Rate (SER)

One way to compute the symbol error rate for a communication system is to simulate the transmission of data messages and compare all messages. Symbol rate is the number of symbol changes or waveform changes across the transmission medium per unit time before and after transmission. The symbol error rate (SER) is the number of bit errors per unit time.

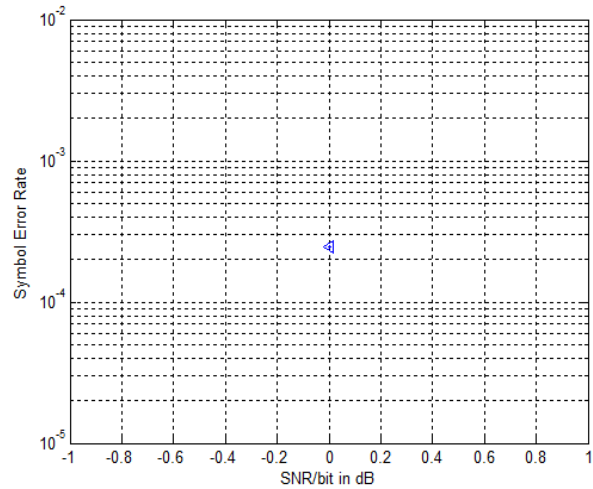

Fig 4.7. SER for 256 subcarriers

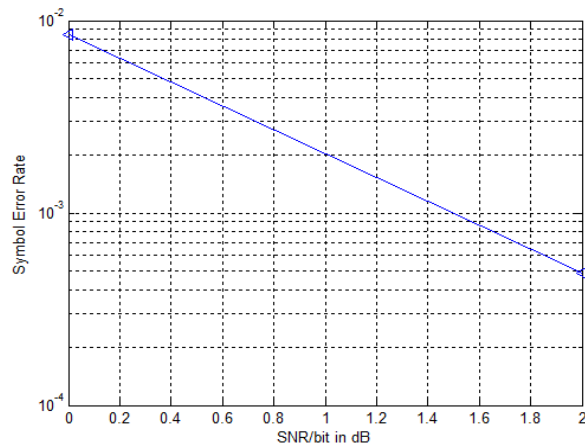

Fig 4.8. SER for 512 subcarriers

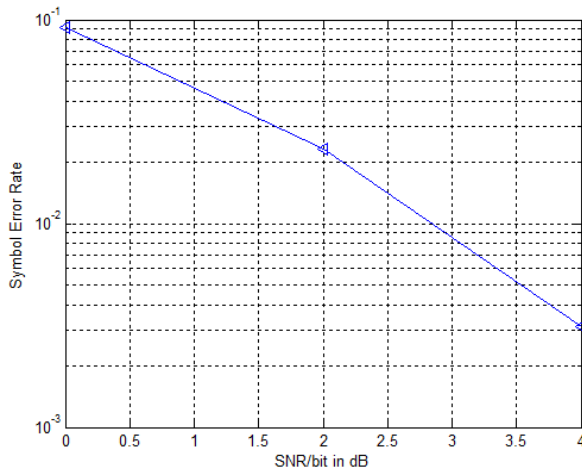

Fig 4.9. SER for 1024 subcarriers

## V. CONCLUSION

PAPR analysis of OFDMA and SC-FDMA showed that the SC-FDMA has less PAPR value. By using pulse shaping filter with high roll off factor, significant reduction of PAPR of OFDMA is achieved but this increases Bandwidth requirement. Therefore, a middle value of Roll off Factor is chosen for this dissertation. Simulated results are obtained for different number of subcarriers and block size for OFDMA and value of PAPR is compared for both by using Pulse Shaping Filter and without using Pulse Shaping Filter. As there is always a scope for capacity improvement. So LTE Capacity is computed by Monte Carlo method. The value of capacity is improved by using Carrier Aggregation and Water Filling Algorithm. Carrier aggregation increases the Bandwidth and Water Filling Algorithm improves LTE Capacity. It is also concluded that SER increases with increase in number of subcarriers.

## REFERENCES

- [1] William J. Hillery, Nitin Mangalvedhe, István Z. Kovács, " A Network Performance Study of LTE in Unlicensed Spectrum" in proceedings of IEEE, 2015.
- [2] B. N. Bondarev and V. S. Kabak, " Calculation of the Peak-to-Average Power Ratio of Signals of OFDM Multichannel Systems" in proceedings of Radio electronics and Communications Systems, Vol. 58, No. 10, pp. 462-469, 2015.
- [3] Ran Zhang, Zhongming Zheng,, Miao Wang, Xuemin Shen, "Equivalent Capacity in Carrier Aggregation-Based LTE-A Systems: A Probabilistic Analysis" in proceedings of IEEE transactions on wireless communications, VOL. 13, NO. 11, pp. 6444-6460, November 2014.
- [4] Madan Pande, Giuseppe Piro, Politecnico di Bari, " Optimal Resource Allocation Scheme for LTE-A Systems with Carrier Aggregation", in proceedings of IEEE ANTS, pp. 1-6, 2014.
- [5] Huda Adibah Mohd ramli, Farah Nadia Mohd Isa, Ani Liza Aswani, " Improved component carrier selection algorithm for downlink Long Term Evolution - Advanced " in proceedings of 5th International Conference on Computer & Communication Engineering, pp. 201-204, 2014.
- [6] Vallari Sharma, Prof. P.K Chopra, " A Survey on LTE Downlink Packet Scheduling " in proceedings of International Journal of Advanced Research in Computer and Communication Engineering Vol. 3, Issue 9, September 2014

- [7] Rasha Alkhansaa, Hassan Artaila, David M. Gutierrez-Estevzb, " LTE-WiFi Carrier Aggregation for Future 5G Systems: A Feasibility Study and Research Challenges" in proceedings of ELSEVIER, pp. 133-140, October 2014.
- [8] Rajnish Saxena, Poonam Singla, Vatsala Sharma, " The Comparative Study of Peak-to-Average Power Ratio Reduction Techniques for LTE OFDM system & its Effect" in proceedings of International Journal of Electronic and Electrical Engineering. Vol. 7, No. 10, pp. 1103-1118, 2014.
- [9] Ashish K. Thakre, Snehal B. Meshram, " Peak-to-Average Power Ratio Reduction in OFDM system using Block Coding technique" in proceedings of International Journal of Advanced Research in Computer and Communication Engineering Vol. 2, Issue 1, January 2013.
- [10] Xiang Zhang, Qi Li , Xinyu Gu , Wenyu Li , Shucong Jia, Lin Zhang, " The Study of Load Balancing Based on the Network Flow Theory in LTE-A systems" in proceedings of IEEE 24th International Symposium on Personal, Indoor and Mobile Radio Communications, pp.91-95, 2013.
- [11] Jean Thierry Stephen Avocanh, Marwen Abdennebi, Jalel Ben-Othman , " A New Two-Level Scheduling Algorithm for the Downlink of LTE Networks" in proceedings of IEEE Globecom - Wireless Networking Symposium, pp. 4519-4523, 2013.
- [12] Dr. G. Indumathi , Dr. Allin Joe, " Design of Optimum Physical Layer Architecture for a High Data Rate LTE Uplink Transceiver" in proceedings of International Conference on Green High Performance Computing, pp. 1-8, 2013.
- [13] Margot Deruyck, Wout Joseph, Bart Lannoo, Didier Colle, and Luc Martens, " Designing Energy-Efficient Wireless Access Networks: LTE and LTE-Advanced" in proceedings of IEEE, 2013.
- [14] Muhammad Mokhlesur Rahman, Shalima Binta Manir, " Performance Analysis of Sc-FDMA and OFDMA in LTE Frame Structure" in proceedings of International Journal of Computer Applications (0975 – 8887) Vol.-45, No.-23, pp. 31-38, May 2012.
- [15] P. Jagatheeswari and M. Rajaram, "Performance Comparison of LDPC Codes and Turbo Codes," in proceedings of European Journal of Scientific Research, Vol.54, No.3, pp.465-472, 2011.
- [16] V. Vijayarangan, DR. (MRS) R. Sukanesh, " An Overview of Techniques for reducing PAPR & its selection criteria for Radio Systems" in proceedings of Journal of Theoretical and Applied Information Technology, pp.25-36, 2009.
- [17] Slimane Ben Slimane, " Reducing the Peak-to-Average Power Ratio of OFDM Signals Through Precodin" in proceedings of IEEE transactions on vehicular technology, Vol. 56, No. 2, pp. 686-695, MARCH 2007.
- [18] Robert D. Maddock, Amir H. Banihashemi, " Reliability-Based Coded Modulation With Low-Density Parity-Check Codes" in proceedings of IEEE transactions on communications, Vol.-54, No. 3, pp. 403-406, MARCH 2006.