

# Study of OFDM Variants and Implementation of OFDM Using fft / ifft

Anshul C.Gurve<sup>1</sup>, S.S.Wasnik<sup>2</sup>, A.D.Bijwe<sup>3</sup>, Ashwini S. Yerlekar<sup>4</sup>, Nilesh Chide<sup>5</sup>

Lecturer, Electronics & Communication Engineering, S.D.M.P., Nagpur, India<sup>1</sup>

Asst. Professor, Electronics & Communication Engineering, P.I.E.T., Nagpur, India<sup>2,3</sup>

Asst. Professor, Information & Technology Engineering, DBACER., Nagpur, India<sup>4</sup>

Asst. Professor, Electronics Engineering, RGCER, Nagpur, India<sup>5</sup>

**Abstract:** Due to the capacity of OFDM to transmit a high-speed data stream using multiple spectral-overlapped lower-speed subcarriers, it has been widely adopted in many new and emerging broadband wireless and wire-line communication systems. OFDM technology offers superior advantages of robustness against inter-carrier, high spectrum efficiency, adaptability to server channel conditions and inter-symbol interference, etc. so such system is adapted in various ways to increase the performance in communication system. OFDM system has gained much attention because it has effective solution for intersymbol interference which caused by dispersive channel. Orthogonal Frequency Division Multiplexing (OFDM) has been recognized as an outstanding method for high-speed cellular data communication where its implementation relies on very high-speed digital signal processing. OFDM systems are used to transmit high speed data rate. The approach of this paper is to study the variants of OFDM, designing of OFDM system and implementation of OFDM.

**Keywords:** fft,ifft,ofdm,vhdl

## I. INTRODUCTION

Orthogonal frequency division multiplexing (OFDM) is a communications technique that divides a communications channel into a number of equally spaced frequency bands. In each band where, a subcarrier carrying a portion of the user information is transmitted. Each subcarrier is orthogonal with other subcarrier, differentiating OFDM from the frequency division multiplexing (FDM). Orthogonal FDM's (OFDM) spread spectrum technique distributes the data over a large number of carriers that are spaced apart at precise frequencies. The various variants of OFDM are COFDM, VOFDM, OFDMA, FOFDM, WOFDM. They are used for terrestrial digital broadcasting; exploiting time, frequency, and spatial diversity; multiplexing operations on user data, Wi-Fi system; fast hopping to spread signals over a given spectrum band respectively. The OFDM system consist of QAM,IFFT,IQAM,FFT, serial to parallel convertor, parallel to serial convertor. The OFDM system is implemented by using VHDL language on Xilinx simulator.

## II. VARIANTS OF OFDM

The various variants of OFDM are COFDM, VOFDM, OFDMA, FOFDM, WOFDM. We will discuss each of them.

### A) COFDM

COFDM has been implemented in Europe for terrestrial digital broadcast services. [11]By using time and frequency diversity OFDM provides a means to transmit data in a frequency selective channel. However, it does not suppress fading itself. Depending on their position in the frequency

domain, individual subchannels could be affected by fading. This requires the use of channel coding to further protect transmitted data. Among those channel coding techniques, trellis coded modulation (TCM)<sup>45</sup> combined with frequency and time interleaving is considered the most effective means for a frequency selective fading channel. One of the advantages of OFDM is that it can convert a wideband frequency selective fading channel into a series of narrowband and frequency non-selective fading subchannels by using parallel and multicarrier transmission. Coding OFDM subcarriers sequentially by using specially desined TCM codes for frequency non-selective fading channel is the major reason for using COFDM for terrestrial broadcasting.

### B) VOFDM

VOFDM [12]combines OFDM with spatial processing. In the combined system, OFDM is used to exploit time and frequency diversity whereas spatial processing exploits spatial diversity. Exploiting time, frequency, and spatial diversity gives the greatest benefit.

the following functions are implemented by VOFDM:

1. OFDM. The data rate and the delay spread tolerance are programmable.
2. Channel estimation. An optimum approach is used employing burst-mode training.
3. Synchronization. Both timing and frequency recovery are robust.

4. Spatial processing. In the VOFDM system, spatial processing is known as Interference Cancellation.
5. Both convolution and Reed-Solomon coding are used, in a concatenated fashion. Optimum soft decoding is used in Viterbi decoding by measuring Signal-to-interference-plus-Noise-Ratio.

### C) OFDMA

OFDMA is a multiple-access/multiplexing scheme that provides multiplexing operation of user data streams onto the downlink sub-channels and uplink multiple access by means of uplink sub-channels. In some literature, downlink multiplexing is called OFDM. We use the notion "downlink OFDMA" for downlink multiplexing and "uplink OFDMA" for uplink multiple access. The similar notions are also applied to TDMA and CDMA. Scalability is one of the most important advantages of OFDMA. With the OFDMA subcarrier structure, it can support a wide range of bandwidth. One immediate advantage stemming from scalability is the flexibility of deployment. In OFDMA systems, subchannels maintain orthogonality in multi-path channel. The number of multi-path components does not limit the performance of the system as long as all these multi-paths are within the cyclic prefix window. OFDMA systems therefore are robust to multipath effects.

### D) FOFDM

Fast low-latency access with seamless handoff orthogonal frequency division multiplexing (Flash-OFDM), also referred to as F-OFDM, was based on OFDM and also specified higher protocol layers. This is a variant of OFDM that was developed by Flarion. It uses multiple tones and fast hopping to spread signals over a given spectrum band.

It is a fast wireless broadband technology that can give a wireless broadband link to homes, and supports high data rates at very low packet and delay losses, over a distributed all-IP wireless network. At the heart of the technology is the Radio Router product, enhances magnitude cost advantage over third generation (3G) wireless networks for mobile data access. It operates on a licensed spectrum but at low frequencies like 450MHz, 700MHz, 800MHz, thus achieving larger coverage area with a single base station. It is a particularly good option for emerging markets, and especially for rural areas that may lack other telecommunications infrastructure. FLASHOFDM operating at low frequencies can be feasible for rural and not very densely populated areas, it lacks the sufficient capacity for big cities. The Flash OFDM technology is based on the OFDM air link, that combines the attributes of TDMA and CDMA to address the unique demands posed by mobile users of broadband data and packetized voice applications. It is the only really mobile all-IP based broadband on the markets. It doesn't suffer from the Wi-Fi networks limitations in security and limited coverage, neither the

limitations. The technology allows users travelling at 250km/hour to download data at speeds up to 1.5Mbit/s or upload at speeds up to 500Kbit/s.

### E) WOFDM (Wideband OFDM)

In Wideband OFDM, the spacing between the channels is large enough so that any frequency errors between the transmitter and receiver have no effect on the performance of the system. . It is particularly applicable to Wi-Fi systems. WOFDM allows several independent channels to operate within the same band. This creates an overlay of low-power, multipoint radio networks and point-to-point backbone systems.

## III. DESIGN AND IMPLEMENTATION OF OFDM SYSTEM.

### A) Basic OFDM System

The generation of OFDM signal started from serial to parallel converter. The serial data need to convert into parallel format, since QAM (Quadrature Amplitude Modulation) module requires parallel input . Such parallel data is mapped to appropriate symbol. The parallel symbols are transformed from frequency domain into time domain, using IFFT module. The data is converted into serial format for transmission.[5]

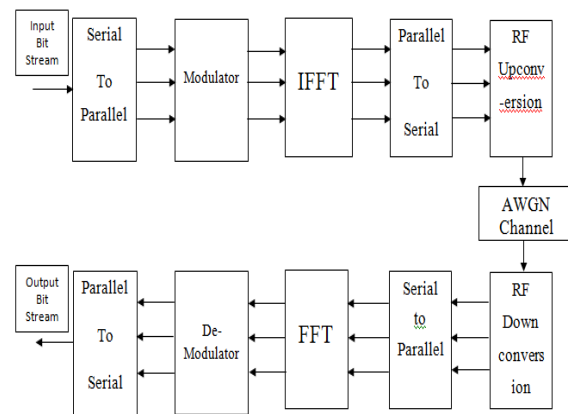

Fig. 1 Basic OFDM system

The received data is in serial format, a module which use to converts from serial to parallel is required. Output from FFT is demodulated, using IQAM. To demodulate the subcarriers using QAM, reference phase and amplitude of the constellation, on each subcarrier. The output of demodulating module is converted back to serial format, through parallel to serial converter, to get the transmitted data [4].

### B ) Implementation

The design of the transmitter is explained first, starting with the top-level design including a port map, top-level FPGA design and detailed explanation of the

transmitter sub-modules. The receiver design is then given a similar treatment. Finally, the validation and verification processes are presented.

### OFDM Transmitter

The model considered for the implementation of the OFDM transmitter is the shown in the Fig. 2, and basically consist of the following blocks:

- Serial to parallel converter.
- Constellation modulator (QAM)
- The IFFT block
- Parallel to serial converter

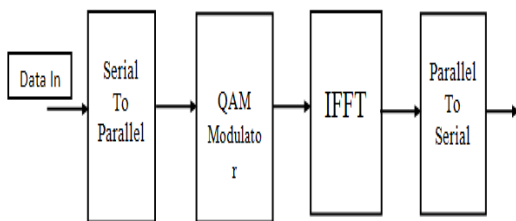

Fig. 2 Block diagram of OFDM Transmitter

Figure 2 above show the simplified block diagram of OFDM transmitter. All block set function is implemented in the FPGA development board. Cyclic prefix module is used to concatenate partial end of information bit and put at the beginning of the information frame.

The generation of OFDM signal started from QAM block. The serial input data is mapped to appropriate symbol to represent the data bits. These symbols are in serial and then convert into parallel format for IFFT. These parallel symbols are transformed from frequency domain into time domain using IFFT block. These signals are converted into serial format.

In serial to parallel converter, which is input block of OFDM transmitter and receiver, data is taken in serial form and converted to parallel form. For this purpose, one register 'temp' is considered for temporary storage of data and after n number of clock cycles, the value in 'temp' is assigned to the output register. Similarly, in parallel to serial converter, for every clock cycle, least significant bit (LSB) of input is assigned to output and this input number is right shifted by one place. In this way, for every clock cycle, we get LSB at output.

The M-QAM encoder converts input data into complex valued constellation points, according to a given constellation, 4QAM, 16-QAM, 32-QAM and so on. The amount of data transmitted on each subcarrier depends on the constellation; 4QAM and 16QAM transmit two and four data bits per subcarrier, respectively. Which constellation to use depends on the quality of the communications channel.

The block encoder can be made by consulting a conversion table, implemented with a LUT that exists in LCs of FPGAs. It is important to notice that in that mapping block, bits are converted into complex symbols (phasors) having the information of the constellation in its I, Q components.

Inverse Fast Fourier Transform (IFFT) is used to generate OFDM symbols. Data bits is represent as the frequency domain . IFFT convert signal from frequency domain to time domain. Where N is number of sample point in data frame. Exponential term represented as twiddle factor that is shown with  $W_N^{nk}$ . Due to twiddle factor calculation performed very fast as it depend on the number of points used. The radix 2 is based on Decimation in Frequency (DIF) and separate the input into two halves.

The parallel to serial converter is only the opposite function of the serial to parallel converter. It is placed just before sending the data through the channel by the digital to analog converter, at the transmitter, and just the last block before obtaining the final data at the receiver.

### OFDM Receiver

The blocks of the OFDM Receiver are shown in the Fig. 3, and those blocks are:

- Serial to parallel converter.
- The FFT block.
- IQAM decoder
- Parallel to serial converter.

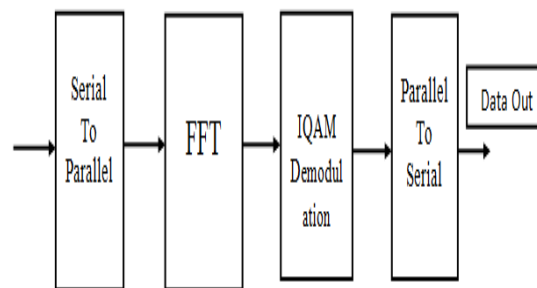

Fig. 3 Block diagram of OFDM Receiver

After the serial to parallel convertor, the signals are passed through an N-point fast Fourier transform to convert the signal to frequency domain. The demodulation can be made by FFT, that is it efficient implementation that can be used reducing the time of processing and the used hardware. FFT calculates DFT with a great reduction in the amount of operations, leaving several existent redundancies in the direct calculation of DFT.

In the receiver, the point of the constellation transmitted it can have changed due to the noises of the transmission channel. The demapper must detect which symbol was most likely transmitted by finding the smallest distance between the received point and the location of a valid symbol in the signal constellation. The constellation demapper then performs the decoding procedure to output

the correct N bit symbol represented by those coordinates. Once the demapper detects the transmitted I-Q coordinates, it can output the difference between the actual constellation point and the received coordinates as an error.

**RESULT :**

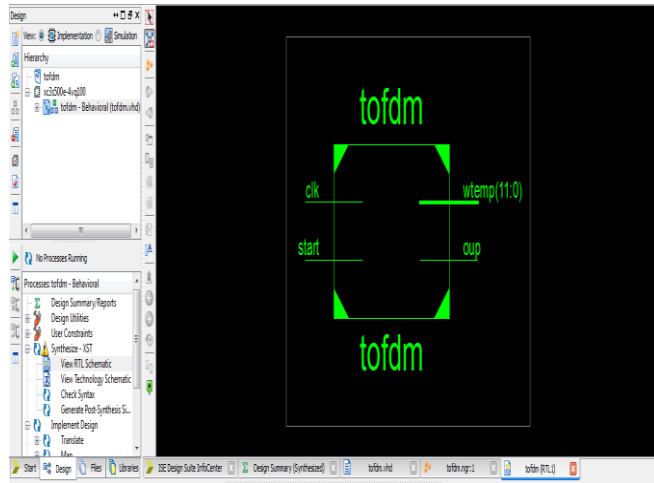

Fig 4 RTL schematic of OFDM transmitter

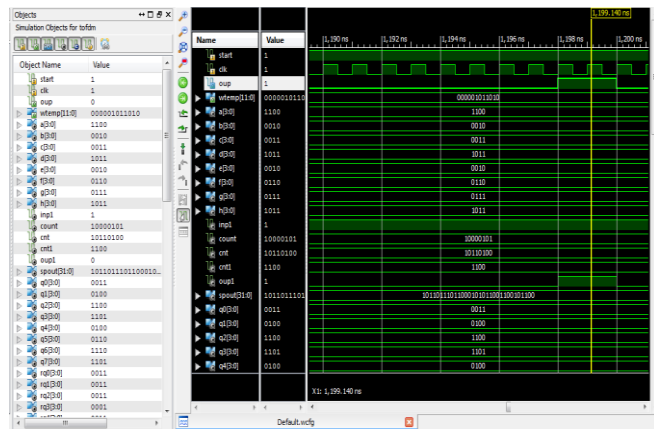

Fig 5 Simulation results of Receiver blocks

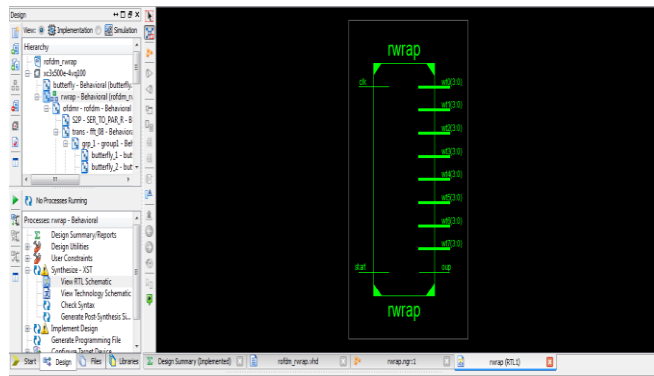

Fig 6 RTL schematic of OFDM receiver

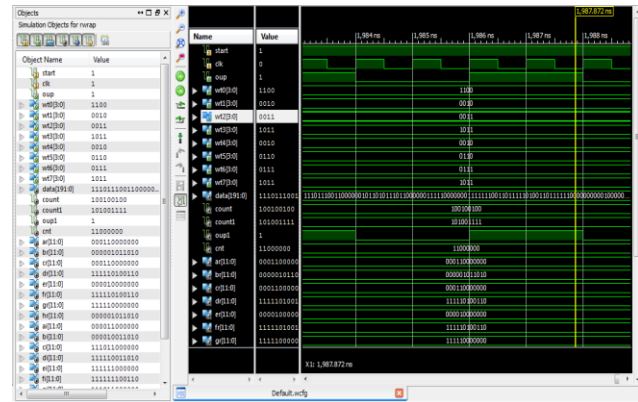

Fig. 7 Test bench waveform of OFDM receiver

**CONCLUSION**

The main aim of the project is to implement the core signal processing blocks of OFDM system on FPGA using VHDL language. The OFDM system is designed on Xilinx project navigator for different number of subcarrier i.e. FFT and IFFT points. They are important and complex blocks in OFDM system which consumes lots of resources. In this project, design for efficient implementation of FFT and IFFT modules is proposed and implemented. The results are matching with expected results.

**REFERENCES**

- [1] Joaquin Garcia, Rene Cumplido, "On the design of an FPGA-based OFDM modulator for IEEE 802.16.", proceedings of 2005 international conference on reconfigurable computing and FPGAs.
- [2] Farzad Manavi, Yousef R. Shayan, "Implementation of an OFDM modem for the physical layer of IEEE 802.11a standard based on Xilinx Virtex-II FPGA.", 0-7803-8255-2/04/\$20.00 2004 IEEE.
- [3] Wen Fan, Chui-sing Choy, "Robust, low complexity and energy efficient downlink baseband receiver design for MB-OFDM UWB system.", IEEE transactions on circuits and system 1549-8328/\$26.00 2011 IEEE.
- [4] R. Van Nee, R. Prasad Publication by Artech House, "OFDM for wireless Multimedia Communications.", e-book.
- [5] R.W. Chang, "Synthesis of band limited Orthogonal Signals for Multichannel data transmission," Bell syst. Tech. J., Vol. 45, pp. 1775-1776, December.1996.
- [6] Salzberg, B. R., "Performance of an efficient parallel data transmission system," IEEE transaction comm., Vol. COM-15, pp. 805-813, December. 1967.
- [7] Weinstein, S. B., and P. M. Ebert, "Data transmission by Frequency Division Multiplexing using the DFT," IEEE Trans. Comm., Vol. COM – 19, pp. 628-634, October.1971.
- [8] Horosaki B., "An orthogonally multiplexed QAM system using the DFT," IEEE Trans. Comm. Vol. COM-29, pp. 982-989, July 1981.
- [9] Kitaek Bae, Student Member, IEEE, Jeffrey G. Andrews, Senior Member, IEEE, and Edward J. Powers, Life Fellow, IEEE, "Quantifying an Iterative Clipping and Filtering Technique for reducing PAPR in OFDM", IEEE Transactions on wireless communications, vol. 9, no. 5, may 2010.
- [9] Michael Bernhard, Joachim Spedel on "Implementation of an IFFT for an Optical OFDM Transmitter with 12.1 Gbit/s".
- [10] Chandrashekar Kukade, R. M. Patrikar, R. B. Deshmukh, "Design & Implementation of OFDM base band for The IEEE 802.11a WLAN", at (VNIT Nagpur).
- [11] William Y Zou, Yiyun Wu."COFDM:AN OVERVIEW" IEEE TRANSACTION ON BROADCASTING. VOL41, NO1, MARCH 1995
- [12] Ender Ayanoglu, VK Jones, Gregory G. Raleigh, James Gardner, Derek Gerlach, karim Toussi, "VOFDM Broadband wireless transmission and its advantages over single carrier modulation", 0-7830-7097-1/01 (C) 2001,IEEE.