

Lab-VIEW Implementation of Automatic Generation Control using Fuzzy Logic Controller

Satyabrata Sahoo¹, Minakshi Pradhan²

Assistant Professor, Department of Electrical Engineering, C.V. Raman College of Engineering, Bhubaneswar, India¹

PG Scholar, Department of Electrical Engineering, C.V. Raman College of Engineering, Bhubaneswar, India²

Abstract: This paper deals with Automatic Generation Control (AGC) of an interconnected Power System using conventional Proportional Integral Derivative (PID) and fuzzy logic controllers. To minimize the effect of noise in the input signal, a filter is employed with the derivative term. A comparative study with PID and Fuzzy is being described on the Lab-VIEW platform.

Keywords: Automatic Generation Control (AGC), PI, Fuzzy Logic, Lab-VIEW.

I. INTRODUCTION

The intelligent systems has necessitated for increase in power demand growth in size and complexity of modern electric power systems. A modern power system network consists of a number of utilities interconnected together and power is exchanged between utilities over tie-line by which they are interconnected. For the stable operation of power systems, it should be maintained both constant frequency and constant tie-line power exchange. In each area, a Load Frequency Controller (LFC) monitors the system frequency and tie-line flows. Many investigations in the area of Load Frequency Control (LFC) problem of interconnected power systems have been reported five decades [1-5].

Load Frequency Controller computes the net change in the generation required (generally referred to as Area Control Error-ACE) and changes the set position of the generators within the area so as to keep the time average of the ACE at a low value. Therefore ACE, which is defined as a linear combination of power net-interchange and frequency deviations, is generally taken as the controlled output of LFC. As the ACE is driven to zero by the LFC, both frequency and tie-line power errors will be forced to zeros. Different control strategies have been employed for load frequency controller's design, in order to achieve better dynamic performance. Among the various types of load frequency controllers, the most widely employed is the conventional proportional integral (PI) controller [6, 7]. Few investigations are carried out MATLAB/SIMULINK base fuzzy logic controller in Automatic Generation Control [8,9].

In view of the above discussion, the following are the main objectives of the present work

1. To apply Lab-VIEW [10] based PID Controller for the automatic generation control and tested for the two areas interconnected system.
2. To apply Lab-VIEW based Fuzzy Logic Controller for the automatic generation control and tested for the two-area interconnected system.
3. To compare the performance of the Conventional PI controller and Fuzzy controller.

II. SYSTEM MODEL

The principle block of the power system studied in this paper is given in Figure 1. Two parts of this system can be considered. A considerable attention should be pay to the LFC (Load Frequency Control) section. Changes in real power mainly affect the system frequency, while reactive power is less sensitive to changes in frequency and is mainly dependent on changes in voltage magnitude. The LFC thus controls the real power and the frequency of the system. It also has a major role in the interconnection of different power plants [11].

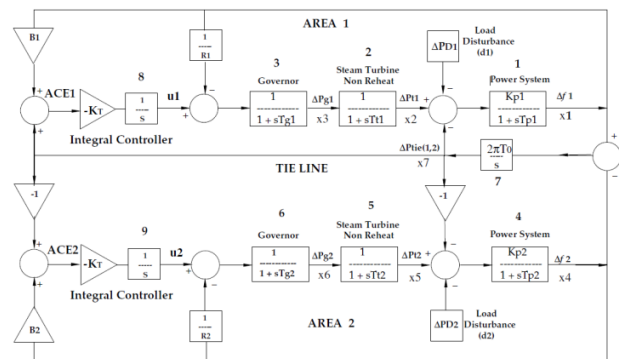

Fig. 1 Transfer function model of two-area system

In each area of figure 1, a Load Frequency Controller (LFC) monitors the system frequency and tie-line flows, computes the net change in the generation required (generally referred to as Area Control Error-ACE) and changes the set position of the generators within the area so as to keep the time average of the ACE at a low value. Therefore ACE, which is defined as a linear combination of power net-interchange and frequency deviations, is generally taken as the controlled output of LFC. As the ACE is driven to zero by the LFC, both frequency and tie-line power errors will be forced to zeros.

III. FUZZY CONTROLLER MODELING

There are three principal elements to a fuzzy logic controller:

- Fuzzification module (Fuzzifier)
- Rule base and Inference engine

- Defuzzification module (defuzzifier)

Fuzzy logic is used to calculate ACE (out) i.e. the control signal in the form of area controller error that will be provided to both the areas to generate according to change in total load to maintain the system frequency within permissible limits. Area control error and change in frequency of the system are used as inputs for Fuzzy logic controller.

The general algorithm for a fuzzy system designer can be Synthesized as follows:

1. Calculate area control error (ACE) and change of frequency (Del F)
2. Calculate the error and change of frequency into fuzzy variable [Positive Big (PB) and Positive medium (PM) etc.]
3. Evaluate the decision rules shown in rule base given below using compositional rule interface.
4. Calculate the deterministic input required to regulate the process

The control rules are formulated in linguistic terms using Fuzzy sets to describe the magnitude of error, the frequency deviation and the magnitude of the appropriate control action.

Table 1: Membership Functions of Δf and ACE

$\Delta F/ACE$	NB	NM	NS	ZO	PS	PM	PB
NB	PB	PB	PB	PM	PM	PS	ZO
NB	PB	PM	PM	PM	PS	ZO	NS
NS	PB	PM	PS	PS	ZO	NS	NM
ZO	PM	PM	PS	ZO	NS	NM	NM
PS	PM	PS	ZO	NS	NS	NM	NB
PM	PS	ZO	NS	NM	NM	NM	NB

Where abbreviations are

Negative Big (NB), Negative Medium (NM), Negative Small (NS), Zero (ZO), Positive Small (PS), Positive Medium (PM), Positive Big (PB).

Membership functions are taken as triangular.

IV. SIMULATION RESULTS

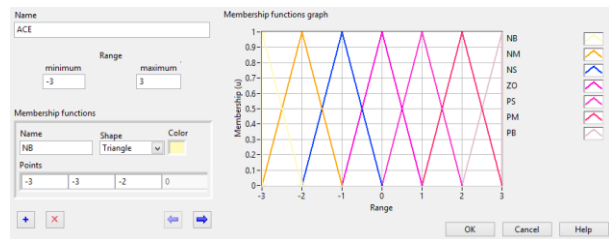

Fig.2 Membership Functions of Area Control Error

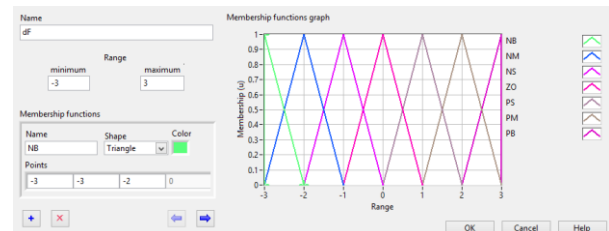

Fig.3 Membership Functions of Change in Frequency

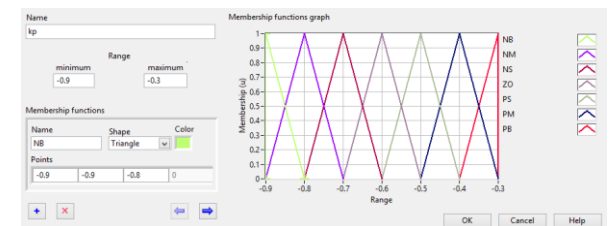

Fig.4 Membership Functions of Proportional Gain

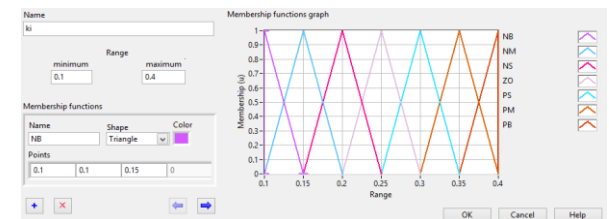

Fig.5 Membership Functions of Integral Gain

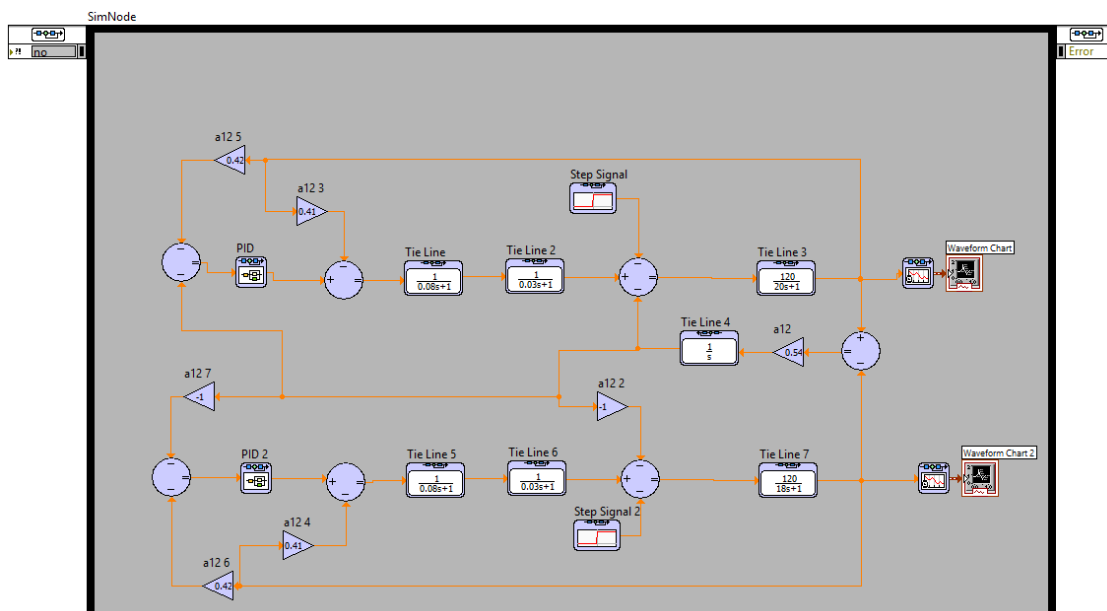

Fig.6 AGC for two area model using PID controller

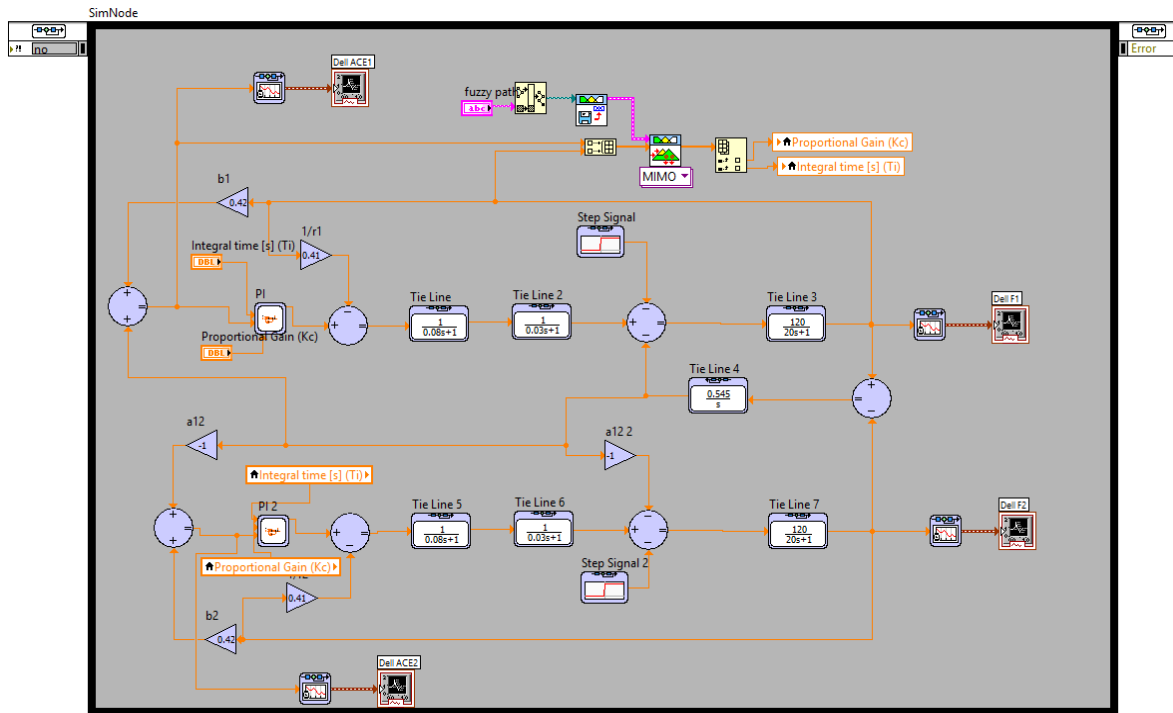

Fig.7 AGC for two area model using Fuzzy controller

In a fuzzy scale, each membership functions of seven linguistic states of triangular type are mapped into the values of Negative Big (NB), Negative Medium (NM), Negative Small (NS), Zero (ZO), Positive Small (PS), Positive Medium (PM), Positive Big (PB). With the 7MFs 49 rules are formed and are applied to the system. The response curves of ΔF_{11} and ΔF_2 shows more stability. The proposed scheme utilizes sugeno-type fuzzy inference system controller,

with the parameters inside the fuzzy inference system. The Fuzzy controller is designed by taking ACE and rate of change of ACE as inputs. Lab-VIEW implemented Membership Functions of Area Control Error, Change in Frequency, Proportional Gain & Integral Gain shown in figure 2, 3, 4 & 5 respectively. The Lab-VIEW model of two-area system with PI controller is shown in Fig.6 and Fuzzy controller is shown in Fig. 7

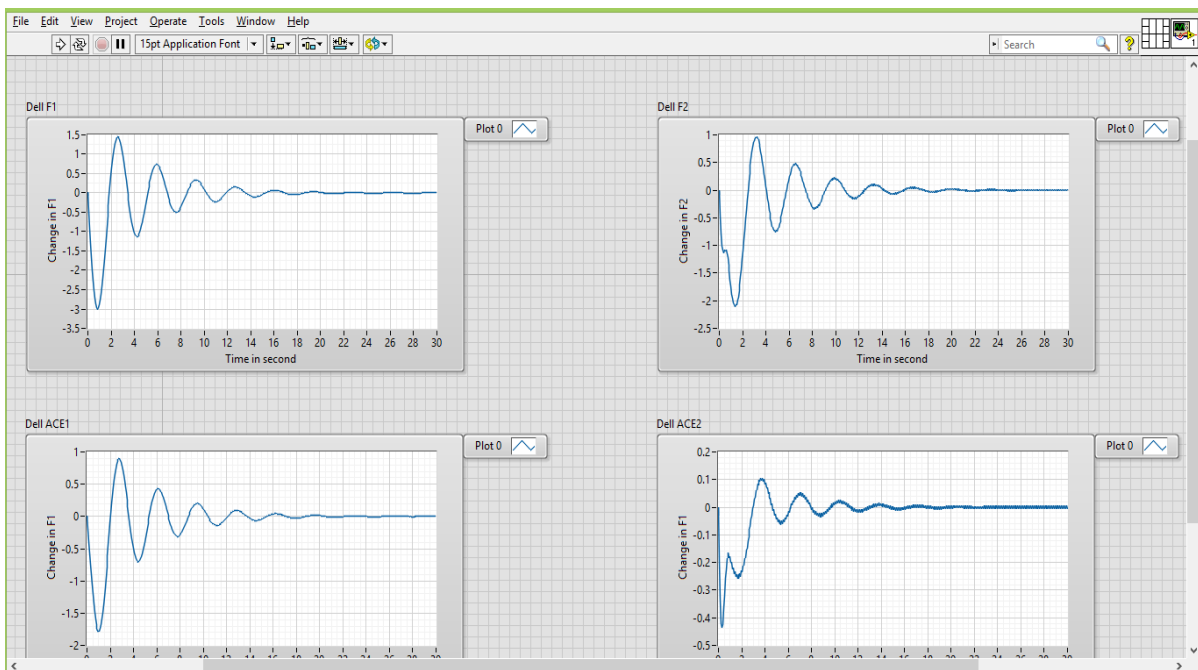

Fig.8 Response of AGC for two area model using PID controller

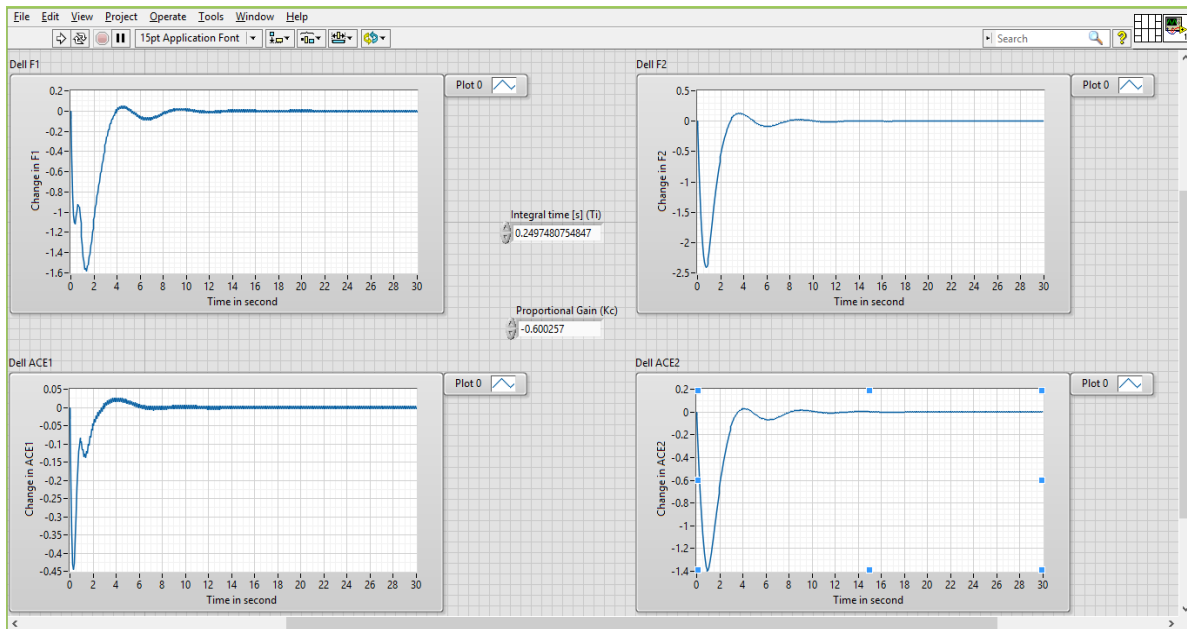

Fig.9 Response of AGC for two area model using Fuzzy controller

V. CONCLUSION

In this study, Fuzzy Logic Controller approach is employed for an Automatic Generation Control (AGC) of interconnected power system. The effectiveness of the proposed controller in decreasing the settling time and Peak over shoot of a two area interconnected power system is demonstrated. Also the simulation results are compared with a conventional PID controller, which is shown in Table-2. The result shows that the proposed intelligent controller is having improved dynamic response and at the same time faster than conventional PID controller.

Table 2: PID and Fuzzy Comparison

Controllers	ACE	ΔF	Settling Time (sec)	Max Peak Overshoot
PID	1	1	22	1.5
	2	2	24	1
FUZZY	1	1	13	0.04
	2	2	12	0.17

REFERENCES

[1] I. J. Nagrath and D. P. Kothari, Power System Engineering, McGraw Hill Co., 1998.
 [2] O. I. Elgerd, Electric energy Systems Theory – An Introduction McGraw Hill Co., 2001.
 [3] A. J. Wood, B. F. Woolenberg, Power Generation Operation and Control, John Wiley and Sons, 1984.
 [4] M. Gopal, “Modern control system theory”, Wiley Eastern Ltd., 2nd edition, 1993.
 [5] G. W. Stagg and A. H. El-Abiad, Computer Methods in Power System Analysis, McGraw Hill Co., 1985.
 [6] M. L. Kothari, J. Nanda, D. P. Kothari, and D. Das, “Discrete Mode automatic generation control of a two-area Reheat thermal system with new area control error”, IEEE Trans. Power Syst., Vol. 4, No. 2, pp. 730-738, May 1989.
 [7] N. Jaleeli, L. VanSlyck, D. Ewart, L. Fink, and A. Hoffmann, “Understanding automatic generation control”, IEEE Trans. Power Syst.,

[8] G.A.Chown and R.C.Hartman, “Design and experience with A Fuzzy Logic Controller for Automatic Generation Control (AGC)”, IEEE Trans. Power Syst., Vol. 13, No. 3, pp. 965-. 970, Nov 1998
 [9] I.H. Atlas and J. Neyens, “A Fuzzy logic Load frequency controller for Power Systems”, International Symposium on Mathematical Methods in Engineering, MME-06, Cankaya University, Turkey, April 27-29,2006. 1999.
 [10] www.ni.com/labview/
 [11] H. Saadat, Power System Analysis, McGraw Hill Book Company, 1999, New York