

A Voltage-Controlled DSTATCOM for Power-Quality Improvement

N.Rajesh Kumar Gowd¹, C.Mohankrishna², M.MD.Sayeedi Baig³

Department of EEE, Sri Krishnadevaraya university College of Engineering & Technology, Anantapuramu, India^{1,3}

Department of EEE, Sri Venkateshwara Institute of Technology Engineering College, Anantapuramu, India²

Abstract: Because of increasing complexity in the power system, voltage sag is getting to be a standout amongst the most critical power quality issues. Voltage sag is a short decrease voltage from nominal voltage, happens in a brief timeframe. On the off chance that the voltage sags surpass a few cycles, and then manufacturing systems making utilization of delicate electronic types of equipments are prone to be influenced prompting real issues. It at last prompts wastage of assets (both material and human) and in addition money related misfortunes. This is conceivable just by guaranteeing that continuous stream of power is kept up at legitimate voltage levels. This project tends to take a solution at the using so as to take care of the sag issues custom power gadgets, for example, Distribution Static compensator (D-STATCOM). Proposed plan takes after another calculation to create reference voltage for a distributed static compensator (DSTATCOM) working in voltage-control mode. The proposed plan guarantees that unity power factor (UPF) is accomplished at the heap terminal amid ostensible operation, which is unrealistic in the conventional technique. Likewise, the compensator infuses lower streams in this manner, diminishes misfortunes in the feeder and voltage-source inverter. Further, a sparing in the rating of DSTATCOM is accomplished which expands its ability to alleviate voltage sag. About UPF is kept up, while directing voltage at the heap terminal, amid burden change. The state-space model of DSTATCOM is joined with the miscreant prescient controller for quick load voltage regulation amid voltage unsettling influences. With these elements, this plan permits DSTATCOM to handle power-quality issues by giving power factor redress, consonant end, load adjusting, and voltage regulation in light of the heap necessity. The performance of the proposed system can be improved by adding Dynamic Voltage Restorer (DVR).

Keywords: DSTATCOM, Dynamic Voltage Restorer (DVR), Voltage Source Converter (VSC).

1. INTRODUCTION

Both electric utilities and end clients of electrical power are turning out to be progressively worried about the quality of electric power. The term power quality has ended up a standout amongst the most productive buzzword in the power business. The issue in electricity power sector conveyance is not kept to just vitality proficiency and environment but rather more importantly on quality and progression of supply or power quality and supply quality. Electrical Power quality is the level of any deviation from the ostensible estimations of the voltage size and recurrence. Power quality might likewise be characterized as the extent to which both the use and conveyance of electric power influences the performance of electrical hardware. From a client point of view, a power quality issue is characterized as any power issue showed in voltage, current or recurrence deviations that outcome in power failure or disoperation of client hardware. Power quality is surely a major worry in the present time, it turns out to be particularly important with the presentation of advanced gadgets, whose performance is exceptionally touchy to the quality of power supply. Cutting edge modern procedures are based a lot of electronic gadgets, for example, programmable logic controllers and customizable rate drives. The electronic gadgets are exceptionally touchy to aggravations and in this way modern burdens turn out to be less tolerant to

power quality issues, for example, voltage dips, voltage swells, harmonics, flickers, interruptions and notches.

Power quality issues are gaining significant attention due to the increase in the number of sensitive loads. Many of these loads use equipment that is sensitive to distortions or dips in supply voltages. Almost all power quality problems originate from disturbances in the distribution networks. Regulations apply in many places, which limit the distortion and unbalance that a customer can inject to a distribution system [1].

These regulations may require the installation of compensators (filters) on customer premises. It is also expected that a utility will supply a low distortion balanced voltage to its customers, especially those with sensitive loads.

A distribution static compensator (DSTATCOM) is a voltage source inverter (VSI)-based power electronic device. Usually, this device is supported by short-term energy stored in a DC capacitor. When a DSTATCOM is associated with a particular load, it can inject compensating current so that the total demand meets the specifications for utility connection. Alternatively, it can also clean up the voltage of a utility bus from any unbalance and harmonic distortion.

2. PROPOSED CONTROL SCHEME

A D-STATCOM (Distribution Static Compensator), which is schematically delineated in Figure, comprises of a two-level Voltage Source Converter (VSC), a dc vitality storage gadget, a coupling transformer associated in shunt to the circulation network through a coupling transformer. The VSC changes over the dc voltage across the storage gadget into an arrangement of three-phase ac output voltages. These voltages are in phase and combined with the ac system through the reactance of the coupling transformer. Suitable modification of the phase and size of the D-STATCOM output voltages permits viable control of active and reactive power trades between the DSTATCOM and the ac system. Such setup permits the gadget to absorb or produce controllable active and reactive power. The VSC associated in shunt with the ac system gives a multifunctional topology which can be utilized for up to three very unmistakable purposes: 1. Voltage regulation and compensation of reactive power; 2. Correction of power factor; and 3. End of current harmonics.

Circuit diagram of a DSTATCOM-compensated distribution system is shown in Fig. 1. It uses a three-phase, four-wire, two-level, neutral-point-clamped VSI. This structure allows independent control to each leg of the VSI [7]. Fig. 2 shows the single-phase equivalent representation of Fig. 1. Variable is a switching function, and can be either or depending upon switching state. Filter inductance and resistance are and , respectively. Shunt capacitor eliminates high-switching frequency components. First, discrete modeling of the system is presented to obtain a discrete voltage control law, and it is shown that the PCC voltage can be regulated to the desired value with properly chosen parameters of the VSI. Then, a procedure to design VSI parameters is presented. A proportional-integral (PI) controller is used to regulate the dc capacitor voltage at a reference value.

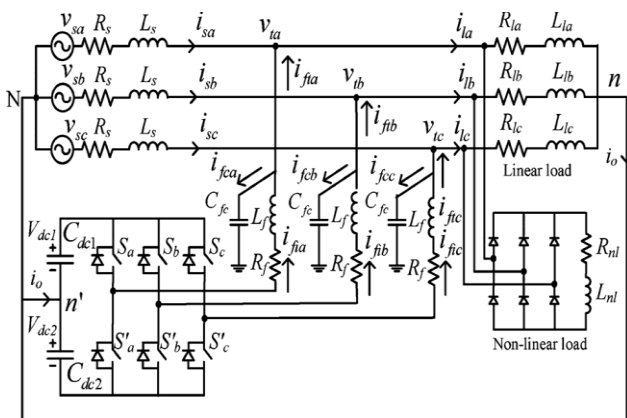

Fig. 1. Circuit diagram of the DSTATCOM-compensated distribution system.

A DSTATCOM is a gadget which is utilized as a part of an AC circulation system where, consonant current alleviation, reactive current compensation and burden adjusting are vital.

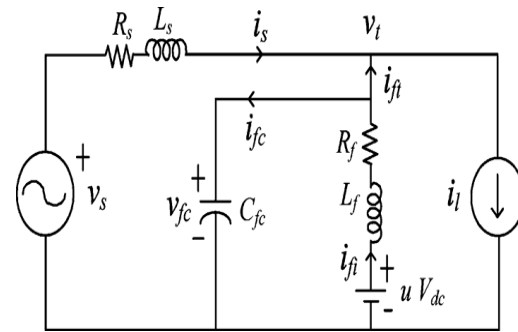

Fig. 2. Single-phase equivalent circuit of DSTATCOM.

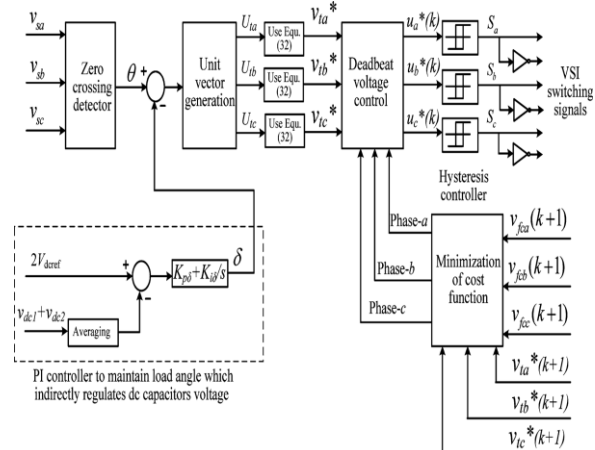

Fig. 3. Overall block diagram of the controller to control DSTATCOM in a distribution system

The building piece of a DSTATCOM is a voltage source converter (VSC) comprising of self commutating semiconductor valves and a capacitor on the DC transport (Singh et al, 2008). The gadget is shunt associated with the power appropriation network through a coupling inductance that is normally acknowledged by the transformer leakage reactance. In general, the DSTATCOM can provide power factor correction, harmonics compensation and load balancing. The major advantages of DSTATCOM compared with a conventional static VAR compensator (SVC) include the ability to generate the rated current at virtually any network voltage, better dynamic response and the use of a relatively small capacitor on the DC bus. The size of the capacitor does not play an important role in steady-state reactive power generation, which results in a significant reduction of the overall compensator size and cost. Fig. 1 shows the schematic diagram of a DSTATCOM connected to a three phase AC mains feeding three phase loads. Three phase loads may be a lagging power factor load or an unbalanced load or non-linear loads or blended of these loads. For decreasing swell in compensating currents, interfacing inductors (L_f) are utilized at AC side of the voltage source converter (VSC). A small arrangement associated capacitor (C_f) and resistor (R_f) speak to the swell channel installed at PCC in parallel with the loads and the compensator to channel the high recurrence exchanging commotion of the voltage at PCC. The harmonics/reactive currents (i_{Cabc}) are infused by the DSTATCOM to cancel the harmonics/reactive power segment of the load currents

so that the source currents are without harmonic (diminishment in harmonics) and load reactive power is also compensated. The rating of the switches is based on the voltage and current rating of the required compensation.

3. VSI PARAMETERS DESIGN

The Dc bus voltage is taken twice the peak of phase voltage of source value. Value of DC capacitors are chosen based on a period of Sag/Swell and change in DC bus voltage during transients [4]. This voltage value continues to decrease until the capacitor voltage controller comes into action. Inductance Filter provides reasonably high switching frequency and sufficient rate of change of current so that VSI currents follow desired currents.

4. POWER INJECTION PRINCIPLE

The total apparent (complex) power that is infused into a transmission line is made up of two segments, namely active and reactive. The active power P segment is the part of vitality that is changed over into physical vitality form. The reactive power Q segment creates the indispensable magnetic medium required for a large portion of today's electromagnetic vitality transformation gadgets and systems. The majority of industrial and commercial appliances require both active and reactive power parts for operation. Both P and Q are required instantly and in various quantities to meet the necessity of the electrical vitality changing over gadget associated with the AC source [3]. Reactive power can be absorbed or supplied relying upon the vitality medium associated with the electric gadget. Vitality absorbing or supplying segments are reactors and capacitors separately.

Reactors absorb reactive power +Q and draw lagging current. The consumed energy is stored as a magnetic energy in the reactor turns. Meanwhile, capacitors supply reactive power -Q and draw leading current, storing it as electric charge within its dielectric medium and associated charge plates. To understand P and Q flow in a transmission system, consider a simple system that is made up of sending and receiving buses with a transmission cable in between

Controller for DC Bus Capacitor Voltage

The voltage of the dc bus of DSTATCOM can be maintained at its reference value by taking inverter misfortunes from the source. On the off chance that the capacitor voltage is regulated to a constant reference value, is a constant value. Subsequently, is also a constant value. In this manner, it is apparent that dc-bus voltage can be regulated by generating a suitable value of .

This incorporates the impact of misfortunes in the VSI and, therefore, it takes care of the term in its action. To calculate load angle , the averaged dc-bus voltage is compared with a reference voltage, and error is passed through a PI controller

Advantages of Dstatcom

- Power factor correction.
- Harmonic elimination
- Load balancing, and voltage regulation
- Based on the load requirement.

5. SIMULATION RESULTS

Terminal voltages and source currents before compensation are plotted in Fig. 4. Distorted and unbalanced source currents moving through the feeder make terminal voltages unbalanced and distorted. Three conditions, namely, nominal operation, operation amid sag, and operation amid load change are compared between the traditional and proposed strategy. In the traditional technique, the reference voltage is 1.0 p.u.

Before compensation, Terminal voltages and source currents.

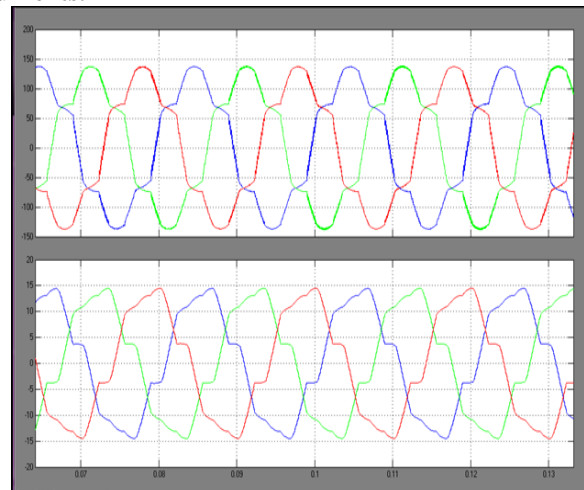

Fig. 4. Before compensation. (a) Terminal voltages. (b) Source currents.

Nominal Operation

Initially, the traditional strategy is considered. Fig. 5 demonstrates the regulated terminal voltages and corresponding source currents in phases. These waveforms are balanced and sinusoidal. In any case, source currents lead individual terminal voltages which demonstrate that the compensator supplies reactive current to the source to overcome feeder drop, in addition to supplying load reactive and harmonic currents

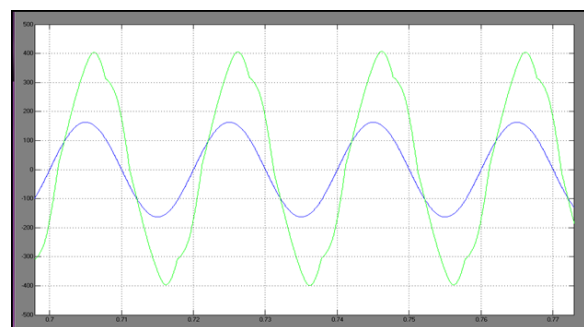

Fig. 5. Terminal voltages and source currents using the traditional method. Phase-a

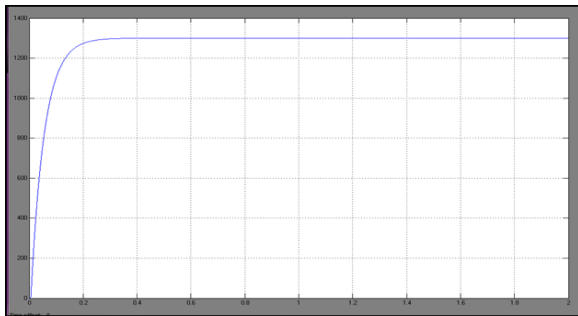

Fig. 6. (a) Voltage at the dc bus.

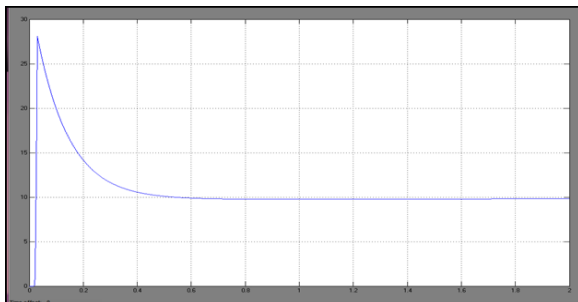

Fig. 6. (b) Load angle.

Using the proposed method, terminal voltages and source currents in phases , , and are shown in Fig. 7(a)–(c), respectively. It can be seen that the respective terminal voltages and source currents are in phase with each other, in addition to being balanced and sinusoidal. Therefore, UPF is achieved at the load terminal

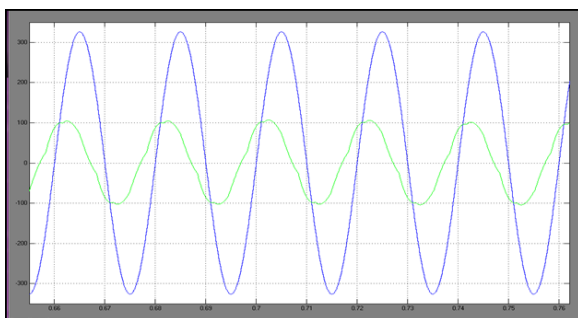

Fig. 7 Terminal voltages and source currents using the proposed method. Phase-a

For the considered system, waveforms of load reactive power, compensator reactive power, and reactive power at the PCC in the traditional and proposed methods are given in Fig. 8(a) and (b), respectively. In the traditional method, the compensator needs to overcome voltage drop across the feeder by supplying reactive power into the source.

This affirms that significant reactive current streams along the feeder in the traditional technique. Be that as it may, in the proposed strategy, UPF is achieved at the PCC by maintaining suitable voltage magnitude. Subsequently, the reactive power supplied by the compensator is the same as that of the load reactive power demand. Therefore, reactive power exchanged by the source at the PCC is zero. These waveforms are given in Fig. 8(b).

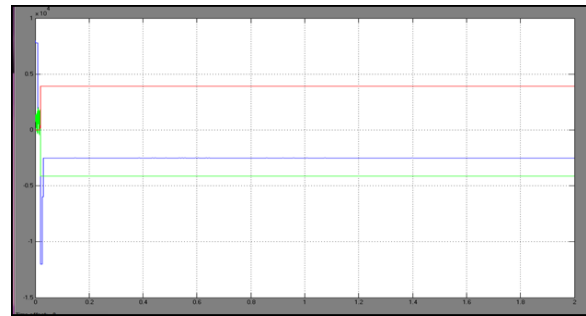

Fig. 8. (a) Load reactive power, compensator reactive power, and reactive power at PCC Traditional method.

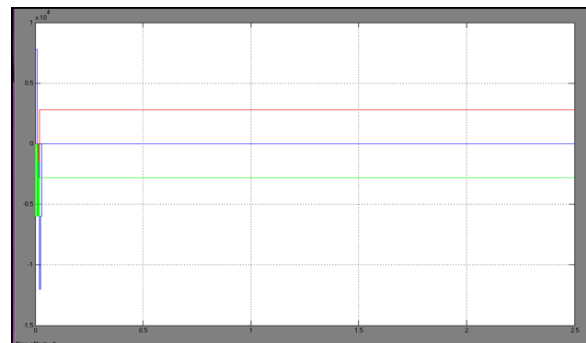

Fig. 8. (b) Proposed method

the PCC is zero. These waveforms are given in Fig. 8(b). Fig. 9(a) and (b) shows the source rms currents in phase for the traditional and proposed methods, respectively. The source current has decreased from 11.35 to 10.5 A in the proposed method. Consequently, it reduces the ohmic losses in the feeder. Fig. 10(a) and (b) shows the compensator rms currents in phase- for the traditional and proposed methods, respectively.

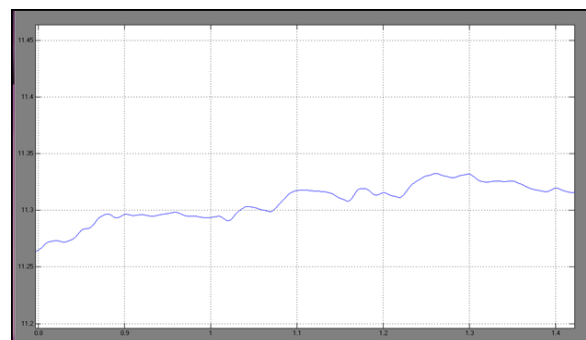

Fig. 9. Phase- source rms currents. (a) Traditional method

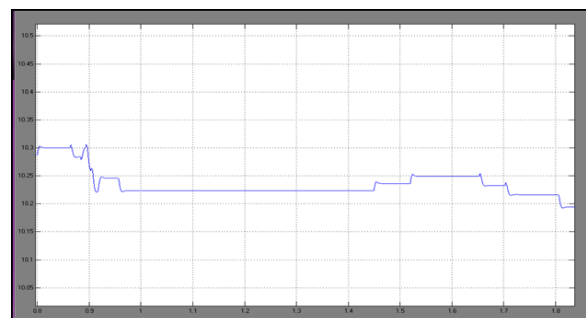

Fig. 9. Phase- source rms currents. (b) Proposed method.

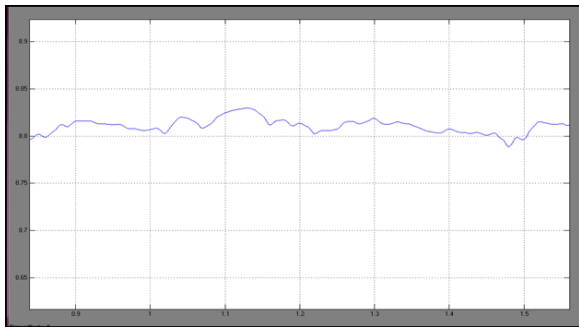

Fig. 10. Phase- compensator rms currents.
(a) Traditional method

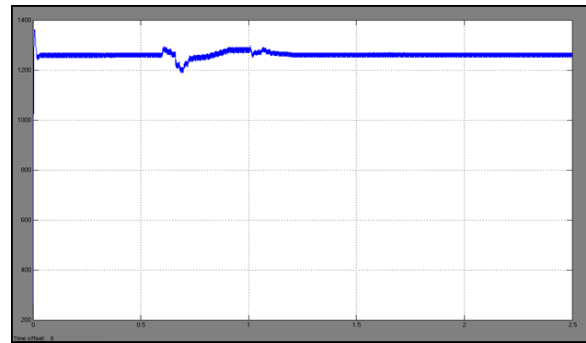

Fig. 11. (c) Voltage at the dc bus.

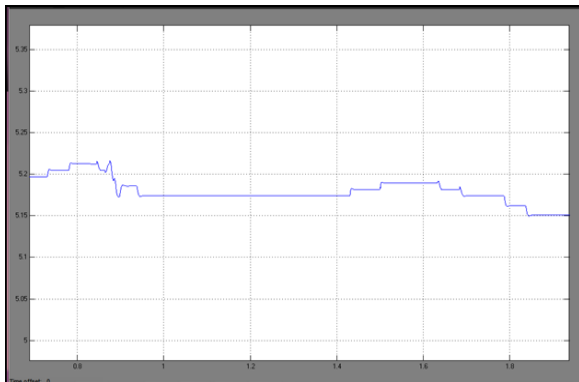

Fig. 10. Phase- compensator rms currents.
(b) Proposed method.

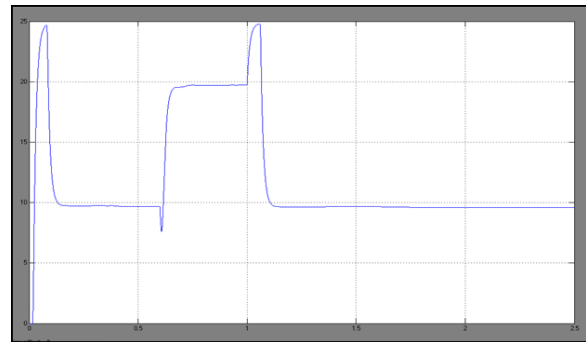

Fig. 11. (d) Load angle.

Operation during Sag

To create sag, source voltage is lowered by 20% from its nominal value at 0.6 s as shown in Fig. 11(a). Sag is removed at 1.0 s as shown in Fig. 11(b). Since voltage regulation capability does not depend upon reference voltage, it is not shown separately for the traditional method

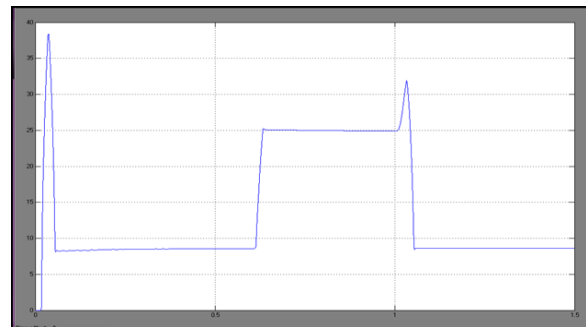

Fig. 11. (e) Compensator rms current in the traditional method

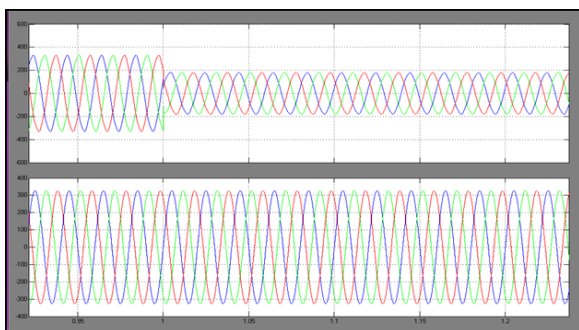

Fig. 11. (a) Source voltages during normal to sag.

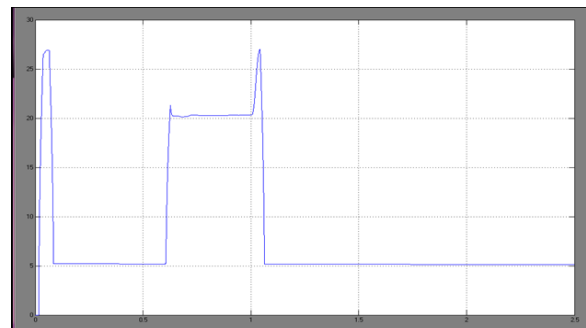

Fig. 11. (f) Compensator rms current in the proposed method.

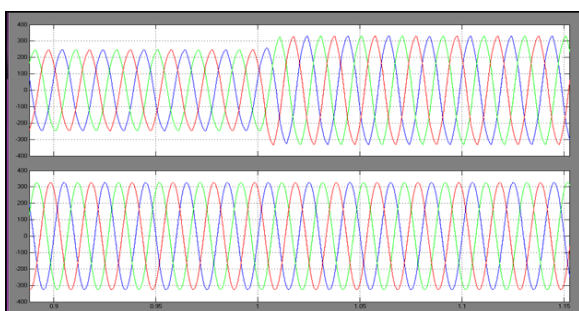

Fig. 11. (b) Source voltages during sag to normal.

To show the capability of DSTATCOM to mitigate deep sag for a longer time, the source voltage is decreased to 60% of the nominal value for 1 to 3 s duration as shown in Fig. 12(a). Fig. 12. (a) Source voltages. (b) Terminal voltages. (c) Voltage at the dc bus. (d) Compensator rms current in the proposed method. Fig. 13. Terminal voltage and source current in phase- during load change.

(a) Traditional method. (b) Proposed method. The terminal voltages, maintained at the reference value, are shown in Fig. 12(b). The voltage across the dc bus is shown in Fig. 12(c). During transients, this voltage deviates from its reference voltage.

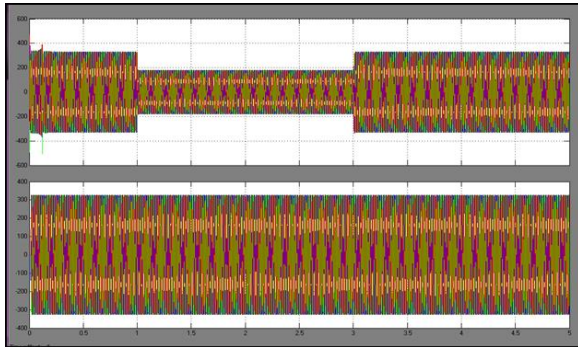

Fig. 12. (a) Source voltages.

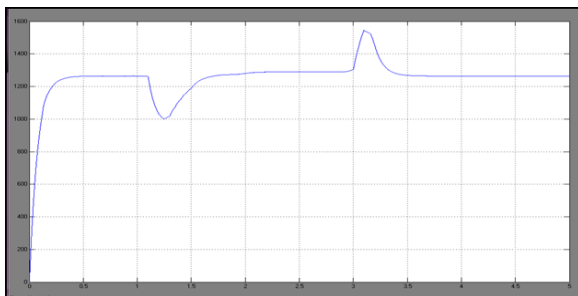

Fig. 12.(b)Voltage at the dc bus.

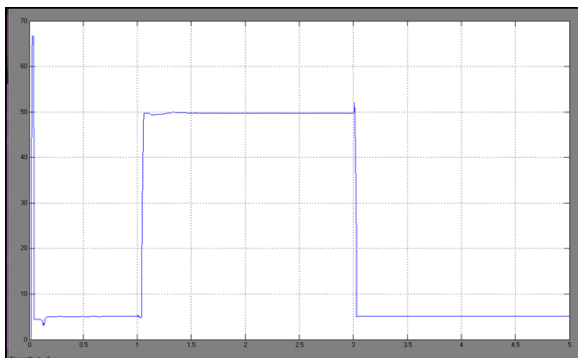

Fig. 12. (c) Compensator rms current in the proposed method.

Operation During Load Change

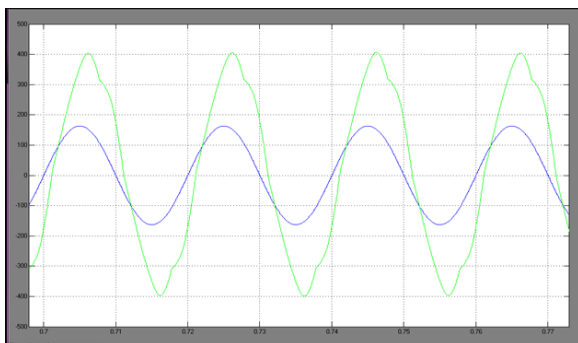

Fig. 13. Terminal voltage and source current in phase during load change. (a) Traditional method

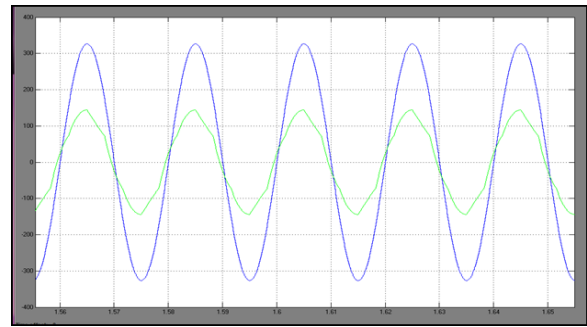

Fig. 13. Terminal voltage and source current in phase during load change (b) Proposed method.

To show the impact of load changes on system performance, load is increased to 140% of its nominal value. Under this condition, the traditional method gives less power factor as the compensator will supply more reactive current to maintain the reference voltage. The voltage and current waveforms, as shown in Fig. 13(a), confirm this. In proposed method, a load change will result in small deviation in terminal voltage from its reference voltage.

DYNAMIC VOLTAGE RESTORER

The Dynamic Voltage Restorer (DVR) is a power electronic device that is used to inject 3-phase voltage in series and in synchronism with the distribution feeder voltages in order to compensate for voltage sag. In this paper the operation of a DVR is presented. The performance of the system can be improved by adding DVR to the system

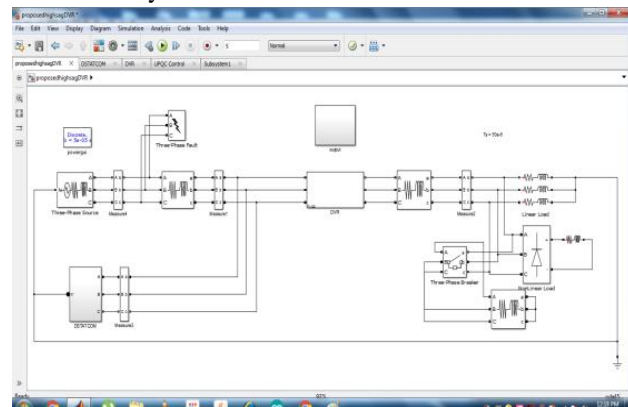

Fig 14 proposed system

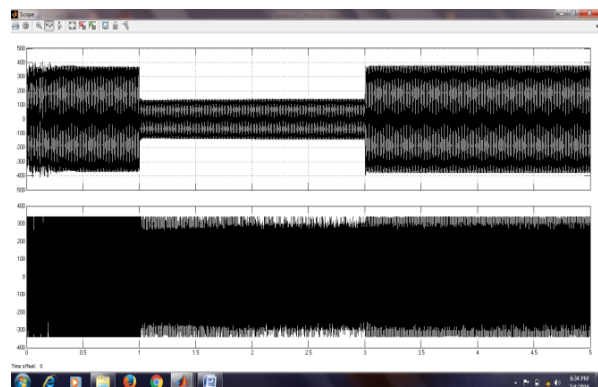

Fig 15 proposed system response for load

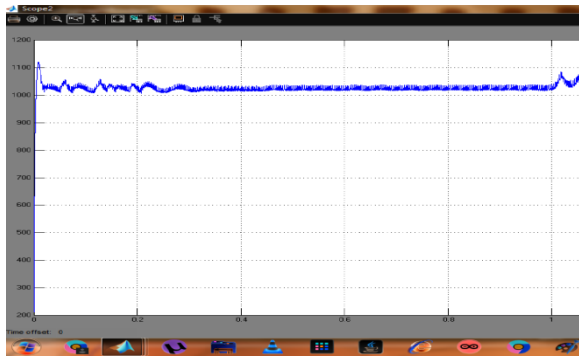

Fig 16 proposed system response for Vdc

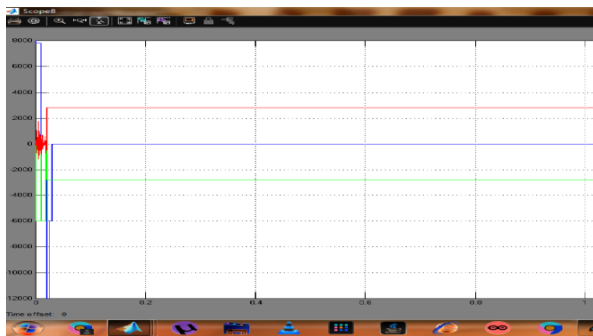

Fig 17 proposed system response for power

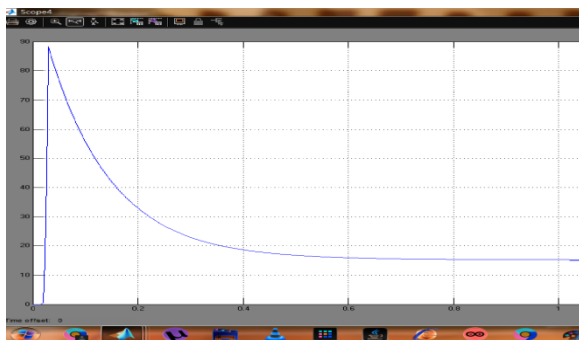

Fig 18 proposed system response for load angle

Dynamic voltage restorer is a static var gadget that has applications in an assortment of transmission and distribution power systems. It is an arrangement remuneration gadget, which ensures touchy electric burden from power quality issues, for example, voltage hangs, swells, unbalance and distortion through power electronic controllers that utilization voltage source converters (VSC). The primary DVR was introduced in North America in 1996 - a 12.47 kV power system situated in Anderson, South Carolina. From that point forward, DVRs have been connected to secure basic burdens in utilities, semiconductor and sustenance handling.

Today, the dynamic voltage restorer is a standout amongst the best PQ gadgets in tackling voltage hang issues. The fundamental standard of the dynamic voltage restorer is to infuse a voltage of required greatness and recurrence, so that it can restore the heap side voltage to the fancied abundance and waveform notwithstanding when the source voltage is unbalanced or distorted. For the most part, it utilizes a Gate turn off thyristor (GTO) strong state

power electronic switches in a pulse width modulated (PWM) inverter structure.

The DVR can produce on the other hand ingest freely controllable genuine and receptive power at the heap side. At the end of the day, the DVR is made of a strong state DC to AC switching power converter that injects an arrangement of three stage AC yield voltages in arrangement and synchronism with the distribution line voltages

6.CONCLUSION

In this project, a control algorithm has been proposed for the generation of reference load voltage for a voltage-controlled DSTATCOM. The performance of the proposed plan is compared with the traditional voltage-controlled DSTATCOM.

The proposed strategy gives the accompanying advantages: 1) at nominal load, the compensator infuses reactive and harmonic parts of load currents, bringing about UPF; 2) nearly UPF is maintained for a load change; 3) fast voltage regulation has been achieved amid voltage disturbances; and 4) misfortunes in the VSI and feeder are lessened considerably, and have higher sag supporting capability with the same VSI rating compared to the traditional plan.

The simulation and experimental results demonstrate that the proposed plan gives DSTATCOM, a capability to enhance several PQ issues. The performance of the proposed system can be improved by adding Dynamic Voltage Restorer (DVR)

REFERENCES

- [1] M. Bollen, Understanding Power Quality Problems. Piscataway, NJ,USA: IEEE, 2000, ch. 1, pp. 1–35.
- [2] H. Fujita and H. Akagi, "Voltage-regulation performance of a shunt active filter intended for installation on a power distribution system," IEEE Trans. Power Electron., vol. 22, no. 3, pp. 1046–1053, May 2007.
- [3] A. Ghosh and G. Ledwich, "Load compensating DSTATCOM in weak ac systems," IEEE Trans. Power Del., vol. 18, no. 4, pp. 1302–1309, Oct. 2003.
- [4] A. Elnady and M. Salama, "Unified approach for mitigating voltage sag and voltage flicker using the DSTATCOM," IEEE Trans. Power Del., vol. 20, no. 2, pt. 1, pp. 992–1000, Apr. 2005.
- [5] S. Rahmani, A. Hamadi, and K. Al-Haddad, "A Lyapunov-functionbased control for a three-phase shunt hybrid active filter," IEEE Trans. Ind. Electron., vol. 59, no. 3, pp. 1418–1429, Mar. 2012.
- [6] M. K. Mishra and K. Karthikeyan, "A fast-acting dc-link voltage controller for three-phase DSTATCOM to compensate ac and dc loads," IEEE Trans. Power Del., vol. 24, no. 4, pp. 2291–2299, Oct. 2009.
- [7] M. K. Mishra, A. Ghosh, A. Joshi, and H. M. Suryawanshi, "A novel method of load compensation under unbalanced and distorted voltages," IEEE Trans. Power Del., vol. 22, no. 1, pp. 288–295, Jan. 2007.
- [8] M. K. Mishra, A. Ghosh, and A. Joshi, "Operation of a DSTATCOM in voltage control mode," IEEE Trans. Power Del., vol. 18, no. 1, pp. 258–264, Jan. 2003.
- [9] A. Jain, K. Joshi, A. Behal, and N. Mohan, "Voltage regulation with STATCOMs: Modeling, control and results," IEEE Trans. Power Del., vol. 21, no. 2, pp. 726–735, Apr. 2006.

BIOGRAPHIES

Mr. N. Rajesh Kumar Gowd has pursued his B.Tech from st.john's College of Engg.& Tech, Kurnool and M.Tech from Bharath institute of Engineering and Technology- Ibrahimpatnam , hyderabad. Presently he is working as Lecturer in Dept. of

EEE in Sri Krishnadevaraya University college of Engineering and Technology ,Ananthapuramu. He has published 3 International Journals .His research areas of interest are Electrical Power System,- Wireless Transmission lines, Distribution system, Reliability, Power electronics design.



C. Mohan Krishna M.Tech working as Assistant Professor in SriVenkateshwaraInstitute of Technology Engineering College ANANTAPUR, His areas of interest include Power Electronics.



Mr.M.M.D.Sayeedi Baig is pursuing his B.Tech in Electrical & Electronics Engineering from Sri Krishnadevaraya university College of Engineering & Technology,Anantapuramu.