

Amplitude Noise Reduction in Millimeter- Wave Radio-Over-Fiber Systems by using Filtration Techniques

Neeraj Singh¹, Harmanjit Kaur²

M.Tech, Department of EEE, Arni University, Himachal Pradesh, India¹

Assistant Professor, Department of ECE, Arni University, Himachal Pradesh, India²

Abstract: RoF is a technique widely used in wireless network to control the data traffic over the network. In this radio signals transmits through fiber optic cables in the form of light. It is widely applicable in real time applications. Some other usage of this is cables used for televisions etc. Noise is a parameter which effects the data traveling through fiber cables. There are many techniques available to remove the noise from the signals. Envelope detectors are available to remove the noise from the signals but it is not capable to remove the noise properly from the signals. It takes the high frequency signals as input and produces the output by enveloping the signals. This leads to the distortion in the signals. In this paper modulated technique is used to remove the noise from the signals. This modulation technique is based on traditional noise removal technique. Along with this the filters are used to improve the quality of the signal. After simulation it is proved that the modulation technique with some alterations is an efficient technique to remove the noise.

Keywords: Base station, Radio over Fiber, Electric to optical converter, BER, Q factor.

I. INTRODUCTION

Radio over fiber is a technology which is used to modulate a light through radio signal and the modulated signal is transmitted over an optical fiber to access the wireless networks such as 3G and Wi-Fi simultaneous from the same antenna [1]. Thus, conclude that radio signals are carried over fiber optic cable. From this cable a single antenna is used to receive all the signals having on the cable to a central location where equipment converts these signal [1]. In the traditional approach this criterion was not followed, they require separate equipment for individual signals at the location of the antenna. Due to its simplicity, it has been used in various applications and for multiple purposes also such as in cable television networks [5].

Radio over fiber signals works between two stations known as base station and central station from where wireless signals are transported in optical form [8]. This process is done before signals being radiated through air. Each base station of the network at least communicates with the mobile user's station which is available in the range of that base station. As a result, it helps in reducing the maintenance as well as equipment cost of the network. Radio over Fiber transmission systems are divided into two parts such as RF-over-fiber and IF over fiber respectively [17]. In RF-over-fiber systems radio signals (RF i.e. radio frequency) are imposed on a light wave signal with using high frequency before transmission of the signal on to optical link whereas IF-over-fiber systems radio signals (IF i.e. intermediate frequency) are imposed on a light wave signal with using low frequency before transmission of the signal on to optical link [8].

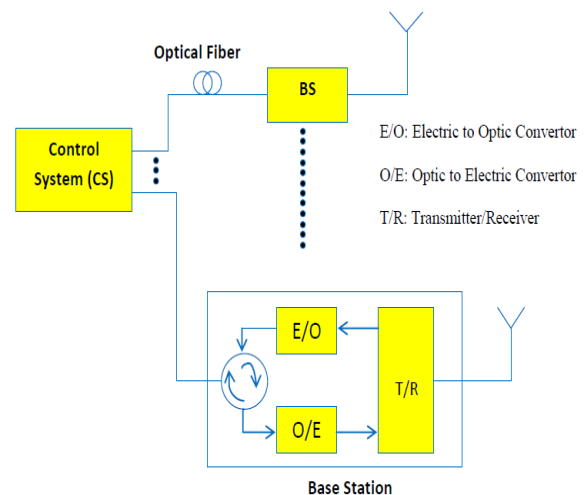

Fig1 Radio over fiber system

II. PROBLEM STATEMENT

The technology in which the radio signals are carried over fiber optics cable for the data transmission is known as radio over fiber (ROF). The light is modulated through the radio signal to facilities wireless access. This is used for multiple purposes like in cable television, Satellite communication etc [17]. The major problem if the radio over fiber communication system is the amplitude noise that degrades the performance of the system. Traditionally many approaches are proposed for minimizing the effect of noise from the signal [8]. Envelop detector was used for

removing the amplitude noise effect, no other filtration method was used to reduce the impact of the amplitude noise from the ROF signal.

The electronic circuit that takes high frequency input signal and output obtained is envelope of the original signal is termed as envelope detector. The major drawback of using envelope detector is that it introduce the distortion in the signal [20]. The distortion is introduced when the signal is modulated. The other disadvantage of using this envelope detector is that it is susceptible to noise from other types of transmissions. To compensate to these drawbacks it is advised to use filters with the input [5]. The input given to the detector should be band-pass filter; otherwise demodulation in signal will occur because of envelope detector. These disadvantages of the envelope detector were the reasons for development of new technique for removing the amplitude noise effect.

So there is need of designing a new ROF system in which the amplitude noise of the signal is reduced, along with the performance of the parameter is also increased.

III. PROPOSED SOLUTION

In ROF system the noise the major factor that degrades the performance of the system. Previously the many approaches were used for the reduction of the amplitude noise. In the previous approach the Envelop detector was reduce the noise but it was not cable to remove the noise completely. Envelope detector is basically an electronic circuit that takes a high-frequency signal as input and provides an output which is the envelope of the original signal. The disadvantage of using envelope detector is the distortion introduced by it. The distortion occurs in the signal only when it is over modulated. The other drawback of using this envelope detector is that it is susceptible to noise from other types of transmissions. To compensate to these drawbacks it is advised to use filters with the input. The input given to the detector should be band-pass filter; otherwise demodulation in signal will occur because of envelope detector. So in this proposed work a new sub carrier system is used along with the components of the system are reduced in order to decrease the complexity of the system. In addition to this the performance parameters of the system like BER, Q factor are also improved. Along with this the traditional modulation technique is also replace by a new modulation technique. This method is considered to better an efficient than the traditional methods of reducing amplitude noise of the ROF system.

A. Transmitter section

In this section the transmitter section is setup. On transmitter side the pseudo code generator is present that is will generate the random signal. A sin generator and a laser source are present. This laser source will generate optical beam that is further send to the receiver. The signal generated from the pseudo generator and the laser source is modulated by using a modulator. In this step the information signal is combined with the light signal and is send to the receiver.

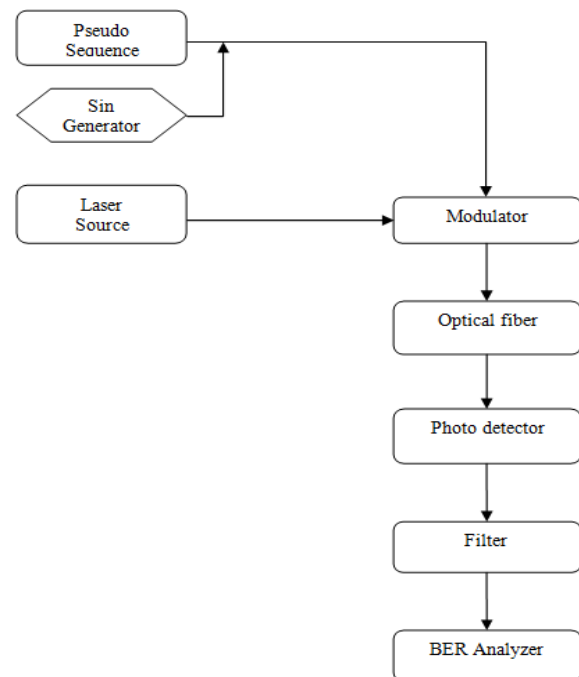

Fig. 2. Block Diagram of Proposed system

B. Signal transmission

In this section the medium for sending the transmitted data is provided. After the modulation, next step is to send the signal through the channel. In this the optical fiber is used for sending the signal from the transmitter end to the receiver end. The optical fiber is better than the traditional electrical wire as they are used for long distance communication Also the loss of information is less. So the optical fiber is used as the medium for transmitting

C. Receiver section

In this receiver section two receivers are used. At the receiver end a photo detector is present this photo detector will convert the light signal into the electrical signal. The output obtained after the photo detector is send to the filter for removing the noise and increasing the signal quality. In this proposed approach two receivers are used each have two different photo detectors having different noises. In this two noises namely shot noise and thermal noise is used. The comparison between the two detectors is done having different noises. The four different systems are designed with two different receiver having different noises. The description of the designed system is given below:

- In first designed system the receiver 1 is used that is having two PIN photo detectors. One PIN photo detector with thermal noise and other with shot noise. The comparison between the results of the photo detector is made.
- In second designed system the receiver 2 is used that is having two PIN photo detectors. One PIN photo detector with thermal noise and other with shot noise. The comparison between the results of the photo detector is made.

- In third designed system the receiver 1 is used that is having two APD. One APD with thermal noise and other with shot noise. The comparison between the results of the photo detector is made.
- In fourth designed system the receiver 2 is used that is having two APD. One APD with thermal noise and other with shot noise. The comparison between the results of the photo detector is made.

D. Performance parameter calculation

In this section the calculation of the performance parameters are done. The final evaluation of the results is done by using the BER analyzer. Various parameters like Q-factor, BER, eye height is done. The effect of the noise on the both the photo detectors is measured that shows the efficiency of the system designed .these parameters will show the performance of the system.

IV. SIMULATION RESULTS

The following figure represents the results obtained by applying proposed system. The following parameters are calculated. The parameters like BER, threshold, Q-factor etc, are calculated. The figure given below represents the BER of the receiver 1 and receiver 2 using photo detectors PIN and APD with shot noise.

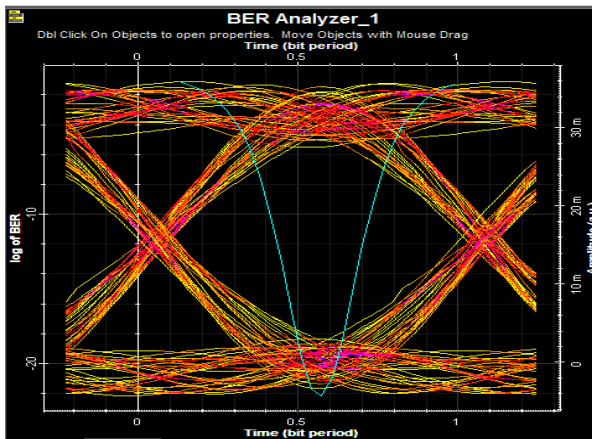

Fig. 3. Receiver 1 PIN with shot noise

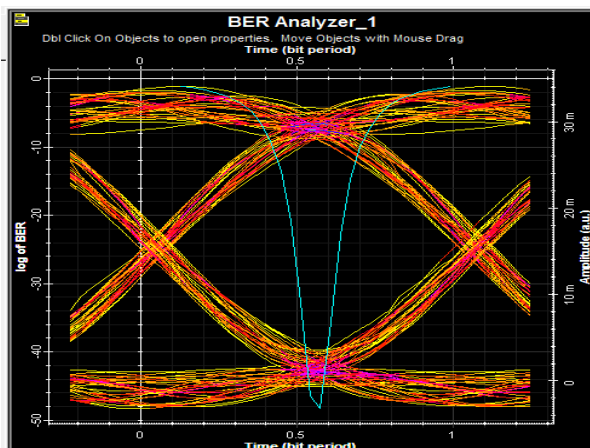

Fig. 4. Receiver 2 PIN with shot noise

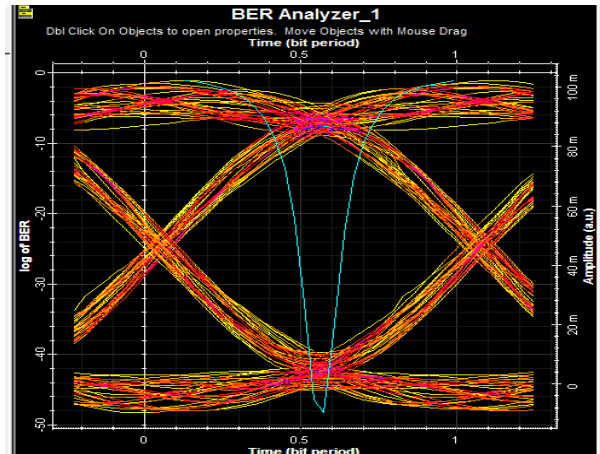

Fig. 5. Receiver 1(APD) with shot noise

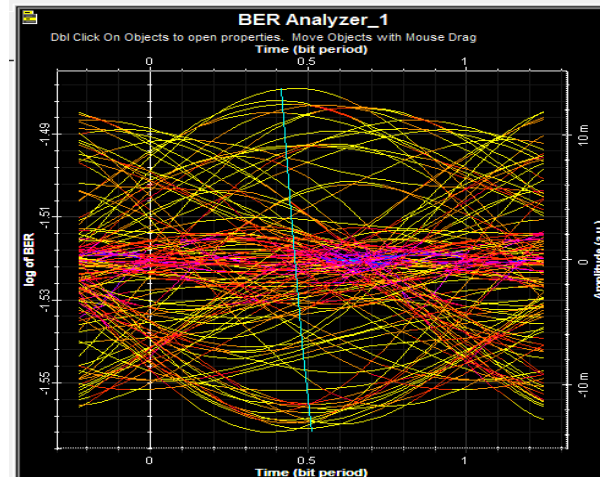

Fig. 6. Receiver 2 (APD) with shot noise

The figures given below represent the graphs of the Q-factor obtained by using different filters for receiver having shot and thermal noise. The comparison graph is between the receiver 1 and receiver 2 with both photo detectors PIN and the APD.

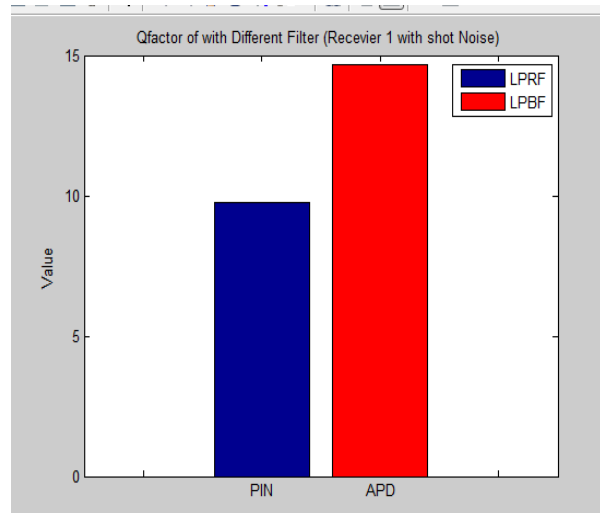

Fig. 7. Represents the comparison graph on the basis of Q- factor for receiver 1 with short noise

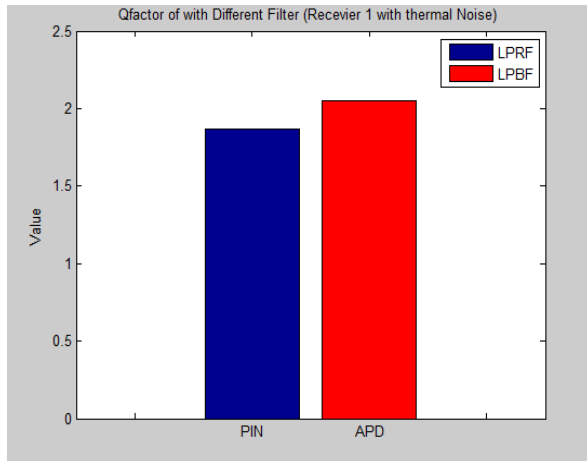

Fig. 8. Represents the comparison graph on the basis of Q- factor for receiver 1 with thermal noise

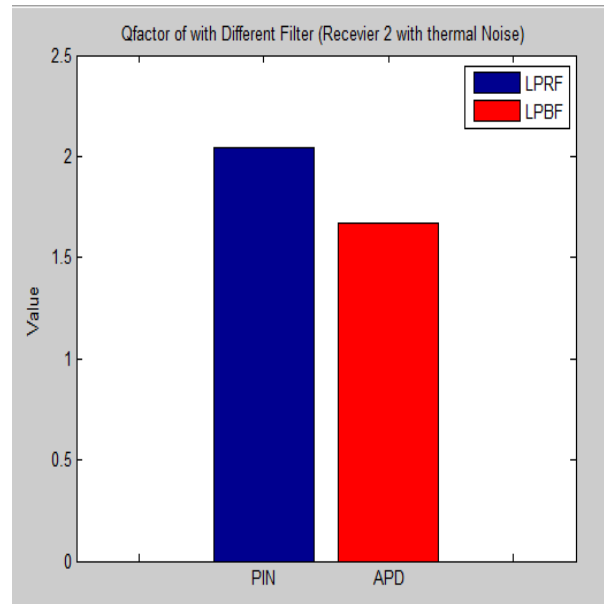

Fig. 10. Represents the comparison graph on the basis of Q- factor for receiver 2 with thermal noise

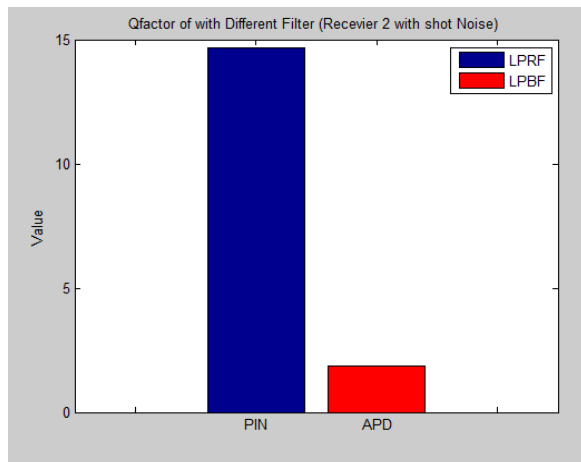

Fig. 9. Represents the comparison graph on the basis of Q- factor for receiver 2 with shot noise

The table given below represent the calculation of various performance parameters like Q-factor, BER, eye height etc. All these parameters are used for defining the performance of the system.

Simulation table 1 represent the receiver 1 and receiver 2 with photo detector PIN with thermal and shot noise.

Simulation table 2 represents the receiver 1 and receiver 2 with photo detector APD with thermal and shot noise.

TABLE I Simulation Table of PIN Photodetector

Parameters	Receiver 1 PIN With Shot Noise	Receiver 1 PIN With Thermal Noise	Receiver 2 PIN With Shot Noise	Receiver 2 PIN With Thermal Noise
Maximum Q-factor	9.77911	1.8648	14.6649	2.03957
Minimum BER	6.90981e-023	0.0308851	5.38638e-049	0.0206919
Eye height	0.0217465	-4.37009e-006	0.022301	-0.000243746
Threshold	0.0146314	4.10486e-006	0.0165421	.000285087
Decision inst.	0.574468	0.861702	0.574468	0.893617

TABLE II Simulation Table of APD Photo Detector

Parameters	Receiver 1 APD with shot noise	Receiver 2 APD with thermal noise	Receiver 1 APD with shot noise.	Receiver 2 with APD thermal noise
Maximum Q-factor	14.6595	2.0513	1.87017	1.67241
Minimum BER	5.831772-049	0.0201166	0.0274214	0.04141746
Eye height	0.0666915	-.000709286	0.00760303	-0.00705024
Threshold	0.049784	0.0008599953	0.00729292	0.00478249
Decision inst.	0.574468	0.893617	0.510638	0.542553

V. CONCLUSION AND FUTURE SCOPE

RoF is a technique which is widely used in wireless networks. It is a technique which is used to transmit the data over the network in the form of optical signals. In this fiber optic cables are used to transfer the data. Noise is parameter which affects the quality of the signals and can corrupt the signals. To prevent the signals from noise many noise removal techniques are used. In this a modulation technique is used to remove the noise from the signals. The idea behind this modulation technique is working of traditional techniques.

In future we can add some other parameters to the modulation technique to remove the noise from the signals. Another methods and parameters can be introduced in the proposed technique to make it much optimum and output efficient.

REFERENCES

- [1] Sreenesh Shashidharan, "Design and Simulation of Radio over Fiber System and its Performance Analysis using RZ coding", International Conference on Electrical, Electronics, Signals, Communication and Optimization (EESCO), 2015.
- [2] Harpreet kaur, "Comparison of NRZ and RZ data modulation formats in SAC-OCDMA system under introduced clock timing jitter of laser diode", International Journal of Advanced Research in Computer and Communication Engineering Vol. 2, Issue 8, Pp 2942 – 2949, 2013.
- [3] Arya Mohan, "Full Duplex Transmission in RoF System using WDM and OADM Technology", IJERT Vol. 4, Issue 01, 2015.
- [4] Osama A, "High Transmission Capacity Performance of Radio Over Fiber System for Short and Long Distances", International Journal of Science, Engineering and Technology Research (IJSETR) Volume 2, Issue 12, Pp 2099- 2106, 2013.
- [5] Shuvodip Das, "Modeling and Performance Analysis of RoF System for Home Area Network with Different line coding schemes using Optisystem", international journal of multidisciplinary sciences and engineering, vol. 5, no. 6, pp 1-8, 2014.
- [6] Virendra kumar, "Design and Performance Analysis of Optical Transmission System", IOSR Journal of Engineering (IOSRJEN), Vol. 04, Issue 05, PP 22-26, 2014.
- [7] AbdEl-Naser A. Mohame, "Transmission Characteristics of Radio over Fiber (ROF) Millimeter Wave Systems in Local Area Optical Communication Networks", Int. J. Advanced Networking and Applications, Volume: 02, Issue: 06, Pp 876-886, 2011.
- [8] El-Sayed A, "New Trends of Radio over Fiber Communication Systems for Ultra High Transmission Capacity", International Journal of Communication Networks and Information Security (IJCNIS) Vol. 3, No.3, Pp 217- 225, 2011.
- [9] R. Holzlohner et al., "Accurate calculation of eye diagrams and bit error rates in optical transmission systems using linearization", journal of light wave technology vol. 20, No. 3, Pp 389-400, 2002.
- [10] S. pachnicke, "Fiber Optical Transmission Systems", Springer, 2012.
- [11] Mohamed et al., "High Transmission Performance of Radio over Fiber Systems over Traditional Optical Fiber Communication Systems Using Different Coding Formats for Long Haul Applications", Nonlinear Optics, Quantum Optics: Concepts in Modern Optics, Vol. 44 Issue 1, p41-63. 23p, 2012.
- [12] Xiaoqiong qi et al., "Fiber Dispersion and Nonlinearity Influences on Transmissions of AM and FM Data Modulation Signals in Radio-Over-Fiber System", IEEE journal of quantum electronics Vol. 46, No. 8, Pp. 1170-1177, 2010.
- [13] F.R.Gfeller et al., "Wireless in-house data communication via diffuse infrared radiation", IEEE, Vol. 67, No. 11, Pp. 1474-1486, 2005.
- [14] A. Lowery et al, "Multiple signal representation simulation of photonic devices, systems and networks", IEEE Vol.6, No. 2, Pp 282-296, 2002.
- [15] Tae-Sik Cho et al, "Effect of Third-Order Intermodulation on Radio-Over-Fiber Systems by a Dual-Electrode Mach-Zehnder Modulator With ODSB and OSSB Signals", journal of light wave technology Vol. 24, No. 5, Pp. 2052, 2006.
- [16] S. Appathurai et al, "Nonlinearity and in-line residual dispersion tolerance of π -AP-RZ and CS-RZ modulation formats in 40-Gb/s transmission over standard single-mode fiber", IEEE photonics technology letters Vol. 17, No. 11, Pp. 2457-2459, 2005.
- [17] Vikas kumar pandey et al, "Radio-Over-Fiber (ROF) Technology With WDM PON System", IJISIR Vol. 7, No. 2, Pp. 78-84, 2014.
- [18] Abd El-Naset A. Mohamed et al., "Radio over Fiber Communication Systems over Multimode Polymer Optical Fibers for Short Transmission Distances under Modulation Technique", IJST Vol. 1, NO. 2, Pp.60-68, 2011.
- [19] R. Karthikeyan et al., "OFDM Signal Improvement Using Radio over Fiber for Wireless System", IJCNWC Vol. 3, No. 3, Pp. 287-291, 2013.
- [20] David Wake et al., "Radio Over Fiber Link Design for Next Generation Wireless Systems", Journal of light wave technology Vol. 28, No. 16, Pp. 2456-2464, 2010.
- [21] T. Niho et al., "Transmission performance of multichannel wireless LAN system based on radio-over-fiber techniques", IEEE Transactions on Microwave Theory and Techniques Vol. 54, No. 2, Pp. 980-989, 2006.
- [22] Michael Sauer et al., "Radio over Fiber for Pico cellular Network Architectures", journal of light wave technology Vol. 25, No. 11, Pp. 3301-3320, 2007.
- [23] S.Ovadia et al., "Performance of hybrid multichannel AM/256-QAM video light wave transmission systems", IEEE Photonics Technology Letters Vol. 7, No. 11, Pp. 1351-1353, 2002.
- [24] B. Huiszoon et al., "Hybrid Radio-Over-Fiber and OCDMA Architecture for Fiber to the Personal Area Network", Journal of Light wave Technology Vol. 27, No. 12, Pp. 1904-1911, 2009.
- [25] Vishal Upadhyay, Arvind Kumar JaiswalA, "Comparative Analysis of Different Modulation Techniques using ROF in Optical Communication System", IJCET 4, 2049-2052, 2014.